

ELECTRICAL SPECIFICATIONS ELEKTRISKA SPECIFIKATIONER

SER. ZETA	CH	HP	LE	LE/HP	MOD.	3.2 - 13.2
------------------	-----------	-----------	-----------	--------------	-------------	-------------------

A)	COMPRESSOR(S) KOMPRESSOR(ER)	MOD. 3.2 2 x 7,5 HP	MOD. 8.2 2 x 15 HP	MOD. 9.2 1 x 20 + 1 x 15 HP	
		MOD. 4.2 2 x 9 HP	MOD. 10.2 2 x 20 HP	MOD. 12.2 1 x 25 + 1 x 20 HP	
		MOD. 5.2 2 x 10 HP	MOD. 13.2 2 x 25 HP		
		MOD. 6.2 1 x 13 + 1 x 10 HP			
		MOD. 7.2 2 x 13 HP			
B)	FAN MOTOR(S) FLÄKTMOTOR(ER)	MOD. 3.2-8.2 2 x 0,59 kW			
		MOD. 9.2-13.2 3 x 0,59 kW			
C)	PUMP(S) PUMP(AR)	MOD. 3.2-4.2	< STD	STD	> STD
			(1 0 2) 0,55 kW	(1 0 2) 0,9 kW	(1 0 2) 1,1 kW
		MOD. 5.2	(1 0 2) 0,55 kW	(1 0 2) 0,9 kW	(1 0 2) 1,5 kW
		MOD. 6.2	(1 0 2) 1,1 kW	(1 0 2) 1,5 kW	(1 0 2) 1,85 kW
		MOD. 7.2	(1 0 2) 1,1 kW	(1 0 2) 1,5 kW	(1 0 2) 2,2 kW
		MOD. 8.2-10.2	(1 0 2) 1,1 kW	(1 0 2) 1,5 kW	(1 0 2) 3 kW
		MOD. 12.2-13.2	(1 0 2) 1,5 kW	(1 0 2) 2,2 kW	(1 0 2) 4 kW

ELECTRICAL SUPPLY LINE
INGÅENDE MATNING

400V 3N ~ 50Hz

AUXILIARY CIRCUIT
MANÖVERSPÄNNING

230V 1 ~ 50Hz
24V 1 ~ 50Hz

ENCLOSED COPIES / BIFOGADE SIDOR

POWER AND AUX. ELECT. DIAGRAM 15 SHEETS
KRAFT OCH MANÖVER. KRETS ELEKT. SCHEMA 15 SIDOR

COMPONENTS LIST 2 SHEET
KOMPONENTLISTA 2 SIDOR

OPTIONALS TILLVAL

RE EVAPORATOR ELECTRIC HEATER ELVÄRME FÖRÅNGARE	RS TANK ELECTRIC HEATER ELVÄRME I BUFFERTTANK	SETP DUAL SET POINT DUBBLA BÖRVÄRDEN
CP FREE CONTACTS POT. FRIA KONTAKTER	1P 1 PUMP 1 PUMP	2P 2 PUMPS 2 PUMPAR
VS SOLENOID VALVE MAGNETVENTIL	COCA EVAPORATING TEMPERATURE CONTROL HOT GAS BY-PASS. FÖRÅNG. TEMPERATUR KONTROLL HET GAS BY-PASS.	CSP SET POINT COMPENSATION BÖRVÄRDES KOMPENSATION
TERM REMOTE TERMINAL FJÄRRTERMINAL	ESIN SUMMER/WINTER FROM DIGITAL INPUT SOMMAR/VINTER VAL FRÅN DIGITAL INGÅNG	PM OVERSIZED PUMPS ÖVERDIMENSIONERAD PUMPKAPACITET
RG FAN SPEED CONTROL STEGLÖS FLÄKTRÄGLERING	COTW OUTLET WATER TEMPERATURE OPERATION KONTROLLERAD VATTENUTGÅNGSTEMPERATUR	PR REDUCED PUMP REDUCERAD PUMPKAPACITET
RIF PHASE ADVANCING CONDENSATOR FASKOMPENSATOR		

Anm. Mikroprocessor $\mu C2$
Magnetventil är standard på HP version, LE version och LE/HP version
Digital input för ON-OFF på kompressorer är standard på LE version och LE/HP version

Modifiering TILLAGDA TILLBEHÖR: " BÖRVÄRDES KOMPENSATION", ELEKTRONISK TERMOSTATVENTIL .

BLUE BOX GROUP - Via E. Mattei, 20 - 35028 PIOVE DI SACCO (PD) - Tel. 049/9716300 - Fax 049/9704105

BESKRIVNING - Denomination
ELSCHEMA FÖR SERIE
ZETA CH - HP - LE - LE/HP MOD. 3.2-13.2

Drawing - Ritning
Z220T10B.ZET

Ersatt ritning - Replace draw.
Z220t10a.ZET

Ersatt med rit - Replaced by draw.
z220t10b.SV.1.dwg

BLUE **BOX**
G R O U P

Datum - Date
08/08/05

Rit. av - Draft.
D.Giacometti

Kontr. av - Checked by
S. Molena

SIDA - PAGE
Z220T10B.000

ELECTRIC CHARACTERISTIC ELEKTRISKA DATA

	MOD.	Icc kA	I sp. A	I max. A	I nom. A	cos fi	* JORDAD KABEL AVSÄKRING	* AREA KABEL mm ²
A	3.2	10	123 (118)	42 (36)	33 (27)	0,78 (0,94)	NH00 50A	10
	4.2	10	158 (152)	48 (42)	37 (31)	0,78 (0,93)	NH00 63A	10
	5.2	10	153 (148)	58 (53)	39 (34)	0,81 (0,94)	NH00 63A	16
	6.2	10	184 (177)	63 (56)	45 (39)	0,80 (0,93)	NH00 80A	16
	7.2	10	188 (182)	67 (61)	50 (44)	0,79 (0,91)	NH00 100A	25
	8.2	10	219 (208)	79 (68)	57 (47)	0,79 (0,96)	NH00 100A	25
	9.2	10	262 (252)	97 (87)	66 (56)	0,81 (0,95)	NH00 125A	25
	10.2	10	278 (268)	113 (103)	71 (60)	0,82 (0,95)	NH00 125A	35
	12.2	10	333 (323)	132 (122)	77 (67)	0,81 (0,94)	NH00 160A	50
	13.2	10	352 (342)	151 (141)	83 (73)	0,82 (0,93)	NH1 200A	70
B	3.2	10	122 (117)	41 (36)	32 (26)	0,78 (0,95)	NH00 50A	10
	4.2	10	157 (151)	47 (41)	36 (30)	0,78 (0,93)	NH00 63A	10
	5.2	10	152 (147)	57 (52)	38 (33)	0,82 (0,95)	NH00 63A	16
	6.2	10	183 (176)	62 (55)	44 (39)	0,80 (0,95)	NH00 80A	16
	7.2	10	187 (179)	66 (58)	49 (42)	0,79 (0,93)	NH00 100A	25
	8.2	10	220 (209)	79 (68)	57 (49)	0,79 (0,96)	NH00 100A	25
	9.2	10	262 (252)	97 (87)	64 (56)	0,81 (0,95)	NH00 125A	25
	10.2	10	276 (268)	111 (101)	69 (60)	0,82 (0,95)	NH00 125A	35
	12.2	10	332 (322)	130 (121)	76 (66)	0,82 (0,94)	NH00 160A	50
	13.2	10	351 (340)	150 (140)	82 (72)	0,82 (0,94)	NH1 200A	50
C	3.2	10	125 (120)	43 (39)	34 (29)	0,78 (0,95)	NH00 50A	10
	4.2	10	159 (154)	49 (43)	37 (33)	0,79 (0,93)	NH00 63A	10
	5.2	10	155 (150)	60 (55)	40 (35)	0,82 (0,95)	NH00 63A	16
	6.2	10	185 (178)	64 (57)	46 (39)	0,80 (0,93)	NH00 80A	16
	7.2	10	189 (182)	68 (61)	52 (45)	0,80 (0,93)	NH00 100A	25
	8.2	10	221 (211)	81 (71)	60 (49)	0,79 (0,96)	NH00 100A	25
	9.2	10	265 (255)	100 (90)	68 (58)	0,80 (0,95)	NH00 125A	25
	10.2	10	280 (270)	115 (105)	73 (64)	0,82 (0,94)	NH00 125A	35
	12.2	10	337 (326)	136 (125)	81 (70)	0,82 (0,94)	NH00 160A	50
	13.2	10	356 (344)	155 (144)	87 (76)	0,81 (0,93)	NH1 200A	50

* BY CUSTOMER
INSTALLERAS AV KUNDEN

() WITH PHASEB ADVANCING CONDENSATOR
() MED FASKOMPENSATOR

BLUE BOX GROUP

SIDAN 2 AV 35

Anm: SV 2006/08/28
z220t10b.SV.2.dwg

1 2 3 4 5 6 7 8 9 10

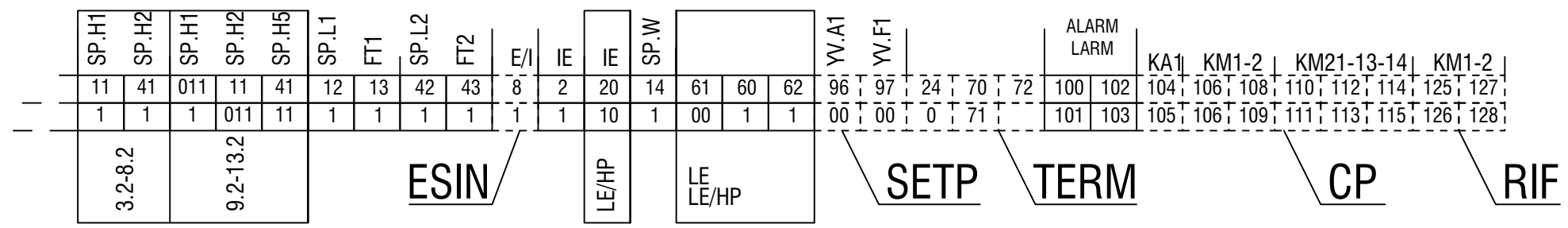
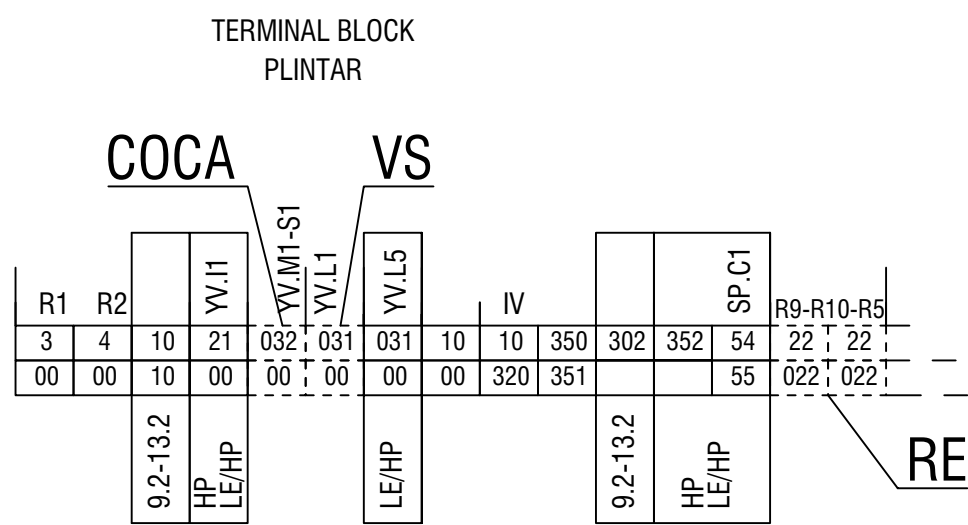
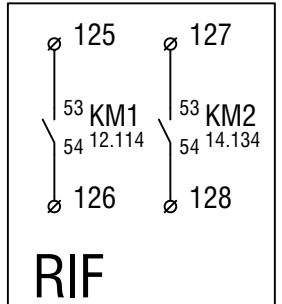
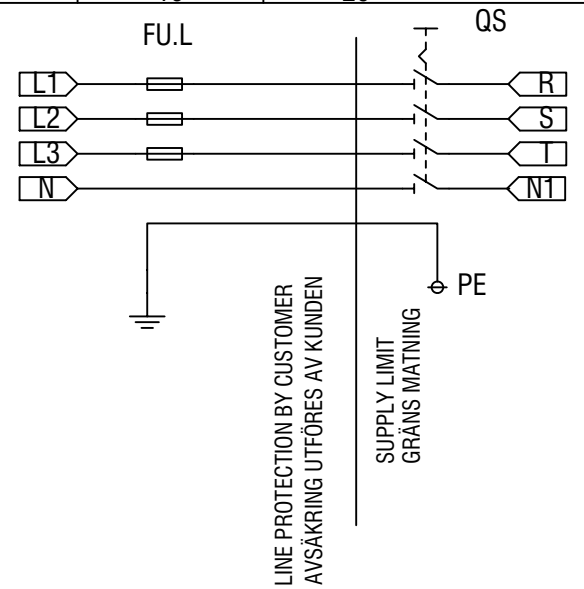
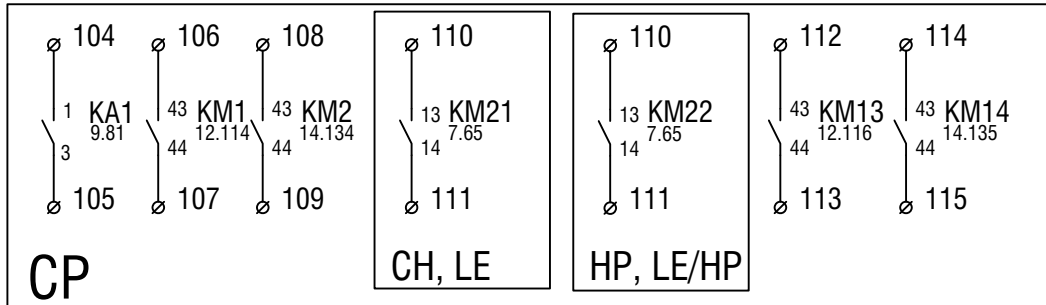
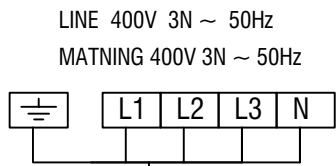

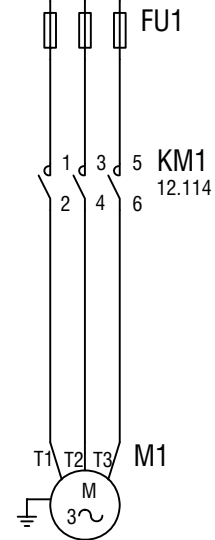
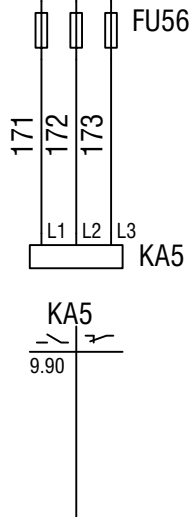
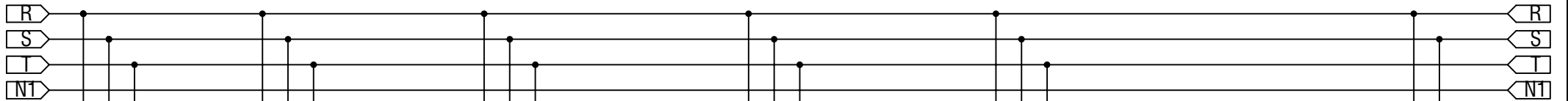

COMPRESSOR 1
KOMPRESSOR 1

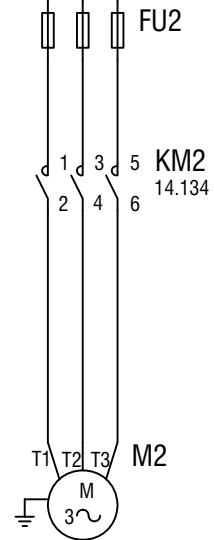

COMPRESSOR 2
KOMPRESSOR 2

COMPRESSOR SECTION LINE AREA KOMPRESSOR KABEL			
MOD.	AREA M1	AREA M2	
3.2	4 mm ² .	4 mm ² .	PVC
4.2	4 mm ² .	4 mm ² .	PVC
5.2	6 mm ² .	6 mm ² .	PVC
6.2	10 mm ² .	10 mm ² .	PVC
7.2	10 mm ² .	10 mm ² .	PVC
8.2	10 mm ² .	10 mm ² .	PVC
9.2	10 mm ² .	10 mm ² .	EPR
10.2	10 mm ² .	10 mm ² .	EPR
12.2	16 mm ² .	16 mm ² .	EPR
13.2	16 mm ² .	16 mm ² .	EPR

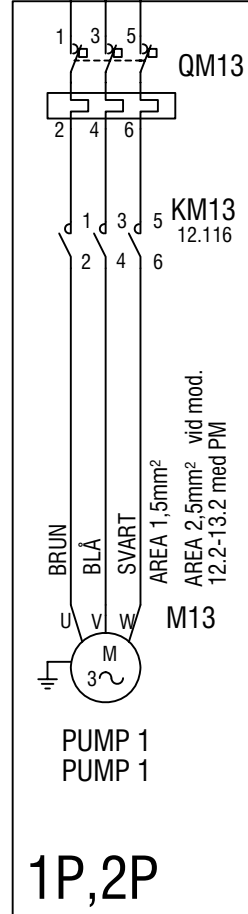

1P,2P

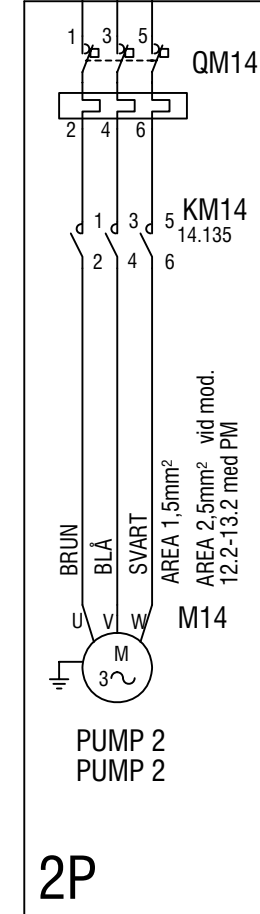

2P

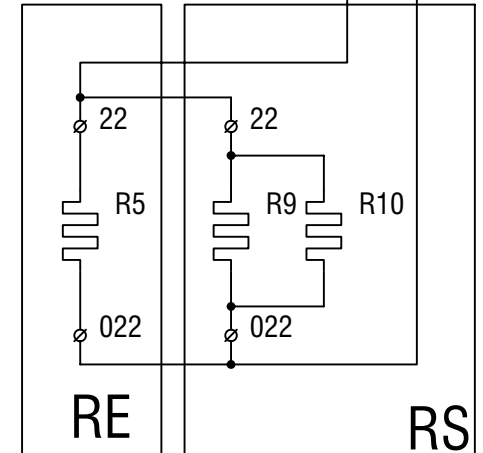
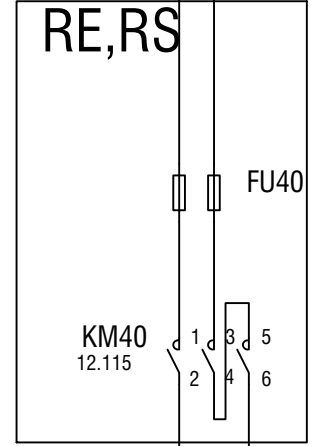

RE

RS

BLUE BOX GROUP
SIDAN 4 AV 35

Anm: SV 2006/08/28
z220t10b.SV.4.dwg

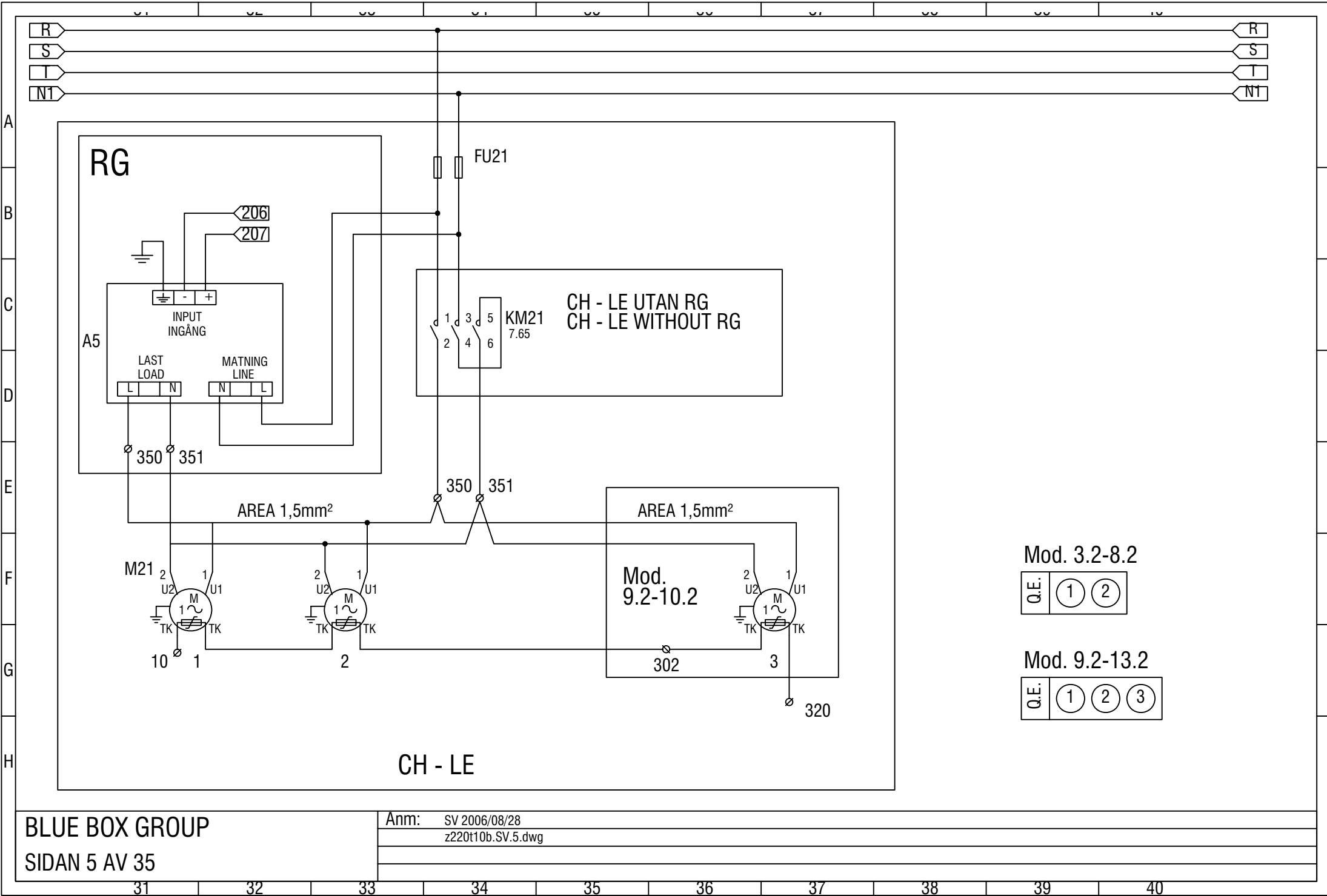

BLUE BOX GROUP
SIDAN 5 AV 35

Anm: SV 2006/08/28
z220t10b.SV.5.dwg

Mod. 3.2-8.2

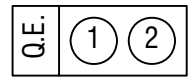

Mod. 9.2-13.2

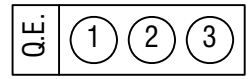

A
B
C
D
E
F
G
H

31 32 33 34 35 36 37 38 39 40

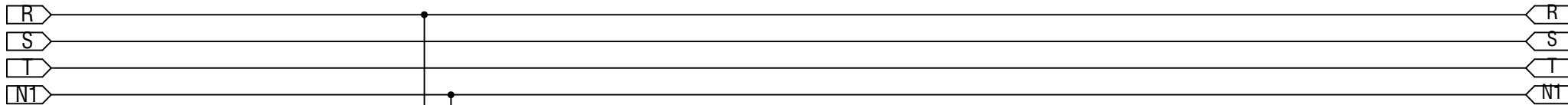

RG

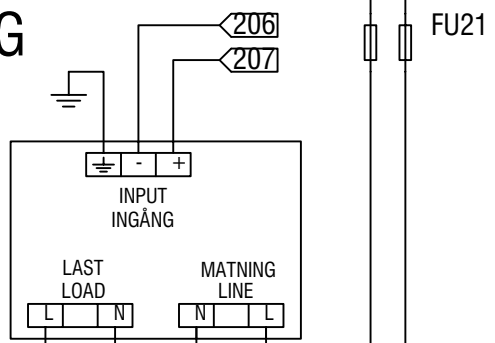

HP - LE/HP MED RG
HP - LE/HP WITH RG

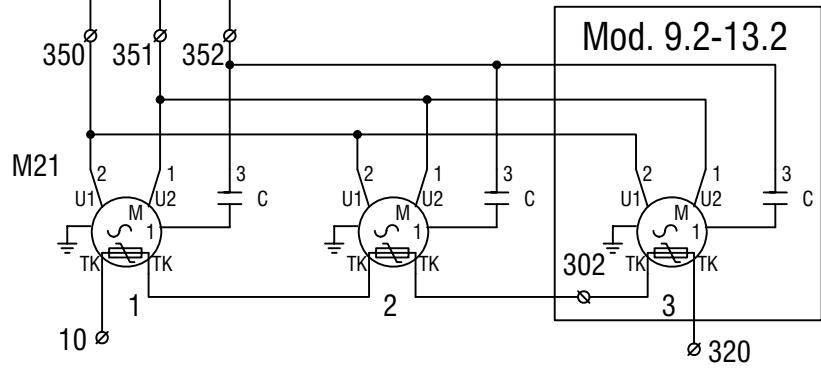
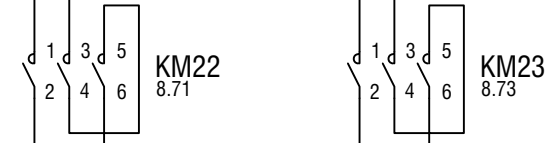

Mod. 3.2-8.2

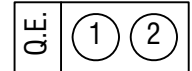

Mod. 9.2-13.2

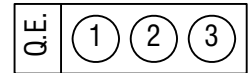

BLUE BOX GROUP
SIDAN 6 AV 35

Anm: SV 2006/08/28
z220t10b.SV.6.dwg

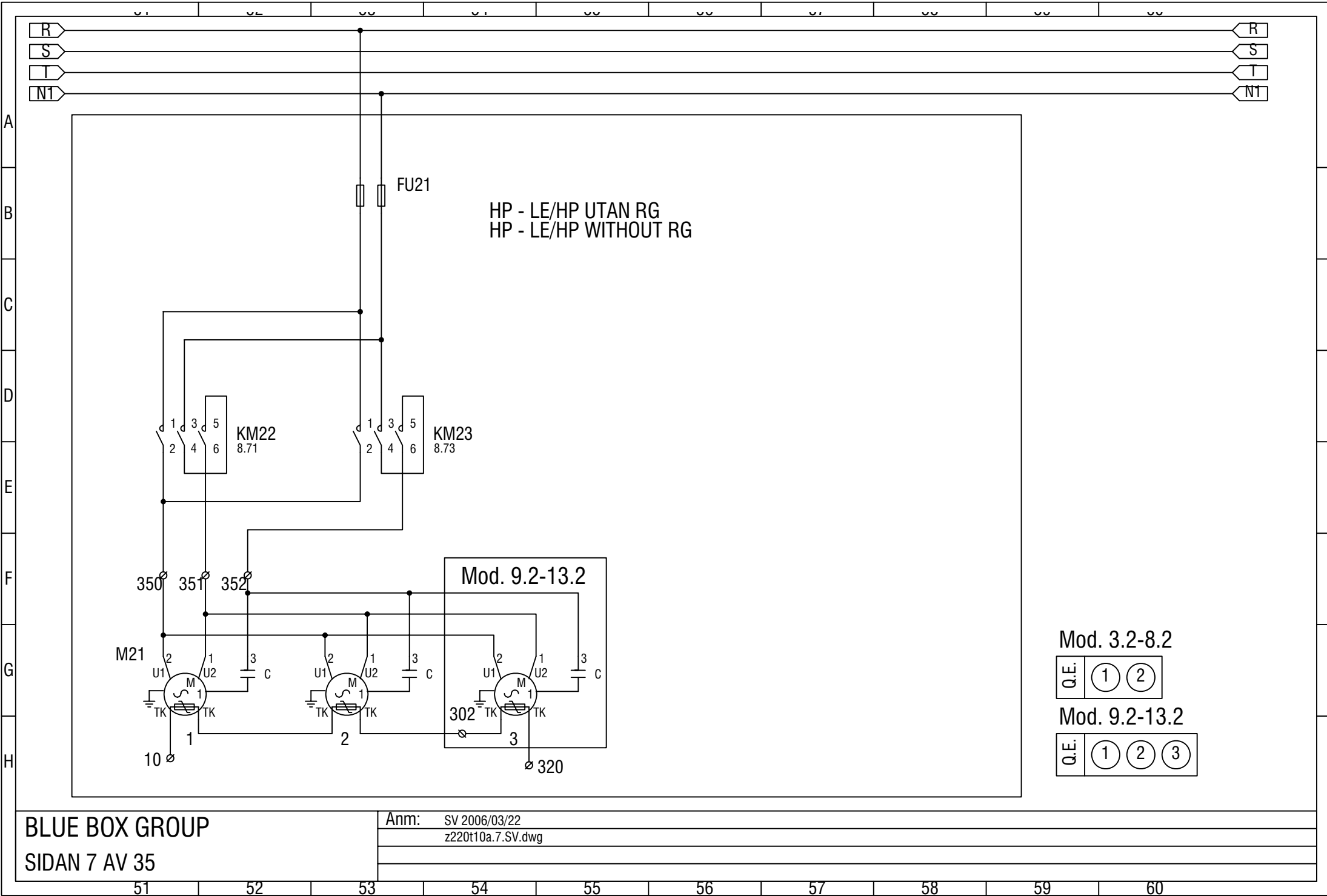

BLUE BOX GROUP
SIDAN 7 AV 35

Anm: SV 2006/03/22
 z220t10a.7.SV.dwg

Mod. 3.2-8.2

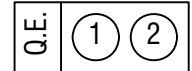

Mod. 9.2-13.2

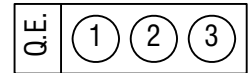

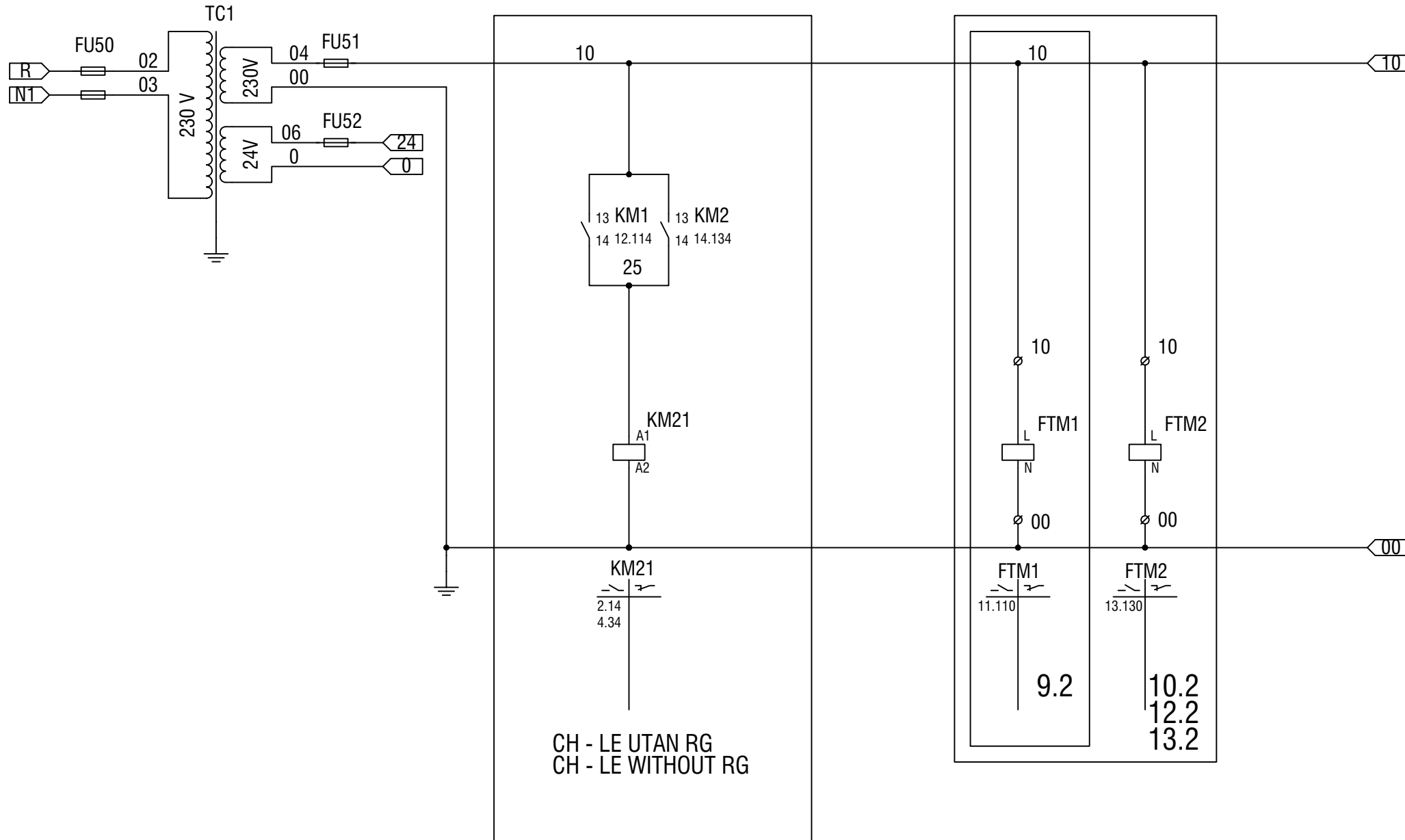

BLUE BOX GROUP

SIDAN 8 AV 35

Anm: SV 2006/08/28
z220t10b.SV.8.dwg

61

62

63

64

65

66

67

68

69

70

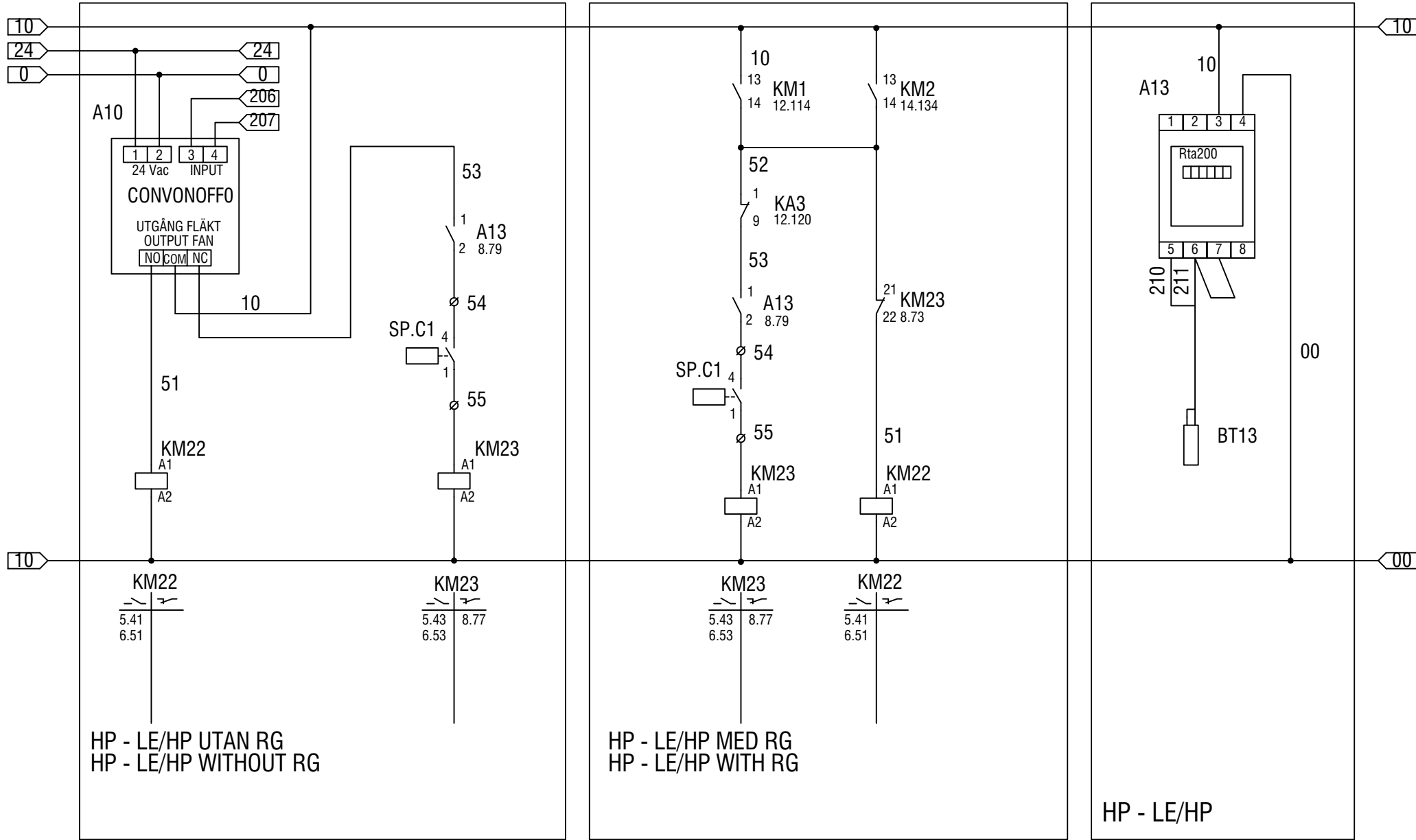

HP - LE/HP UTAN RG
 HP - LE/HP WITHOUT RG

HP - LE/HP MED RG
 HP - LE/HP WITH RG

HP - LE/HP

BLUE BOX GROUP
 SIDAN 9 AV 35

Anm: SV 2006/08/28
 z220t10b.SV.9.dwg

OM FJÄRRSTYRNING ÖNSKAS, ANSLUT DENNA TILL KONTAKTERNA 10-20
 IF IS REQUIRED REMOTE CONTROL MUST BE CONNECTED BETWEEN THE 10-20 CONTACTS

KOPPLAS AV INSTALLATÖREN
 CONNECTION BY INSTALLER

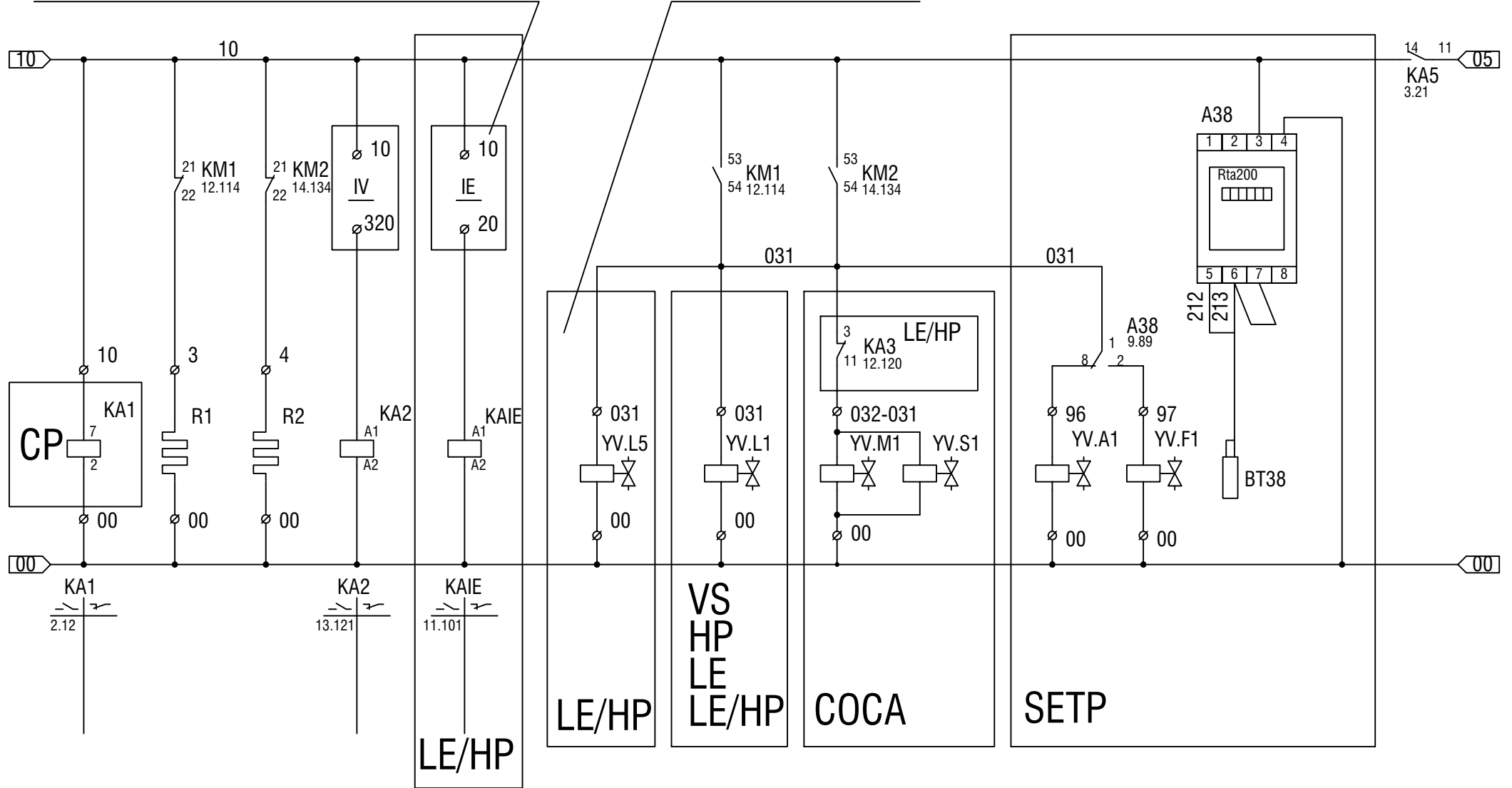

BLUE BOX GROUP
 SIDAN 10 AV 35

Anm: SV 2006/08/28
 z220t10b.SV.10.dwg

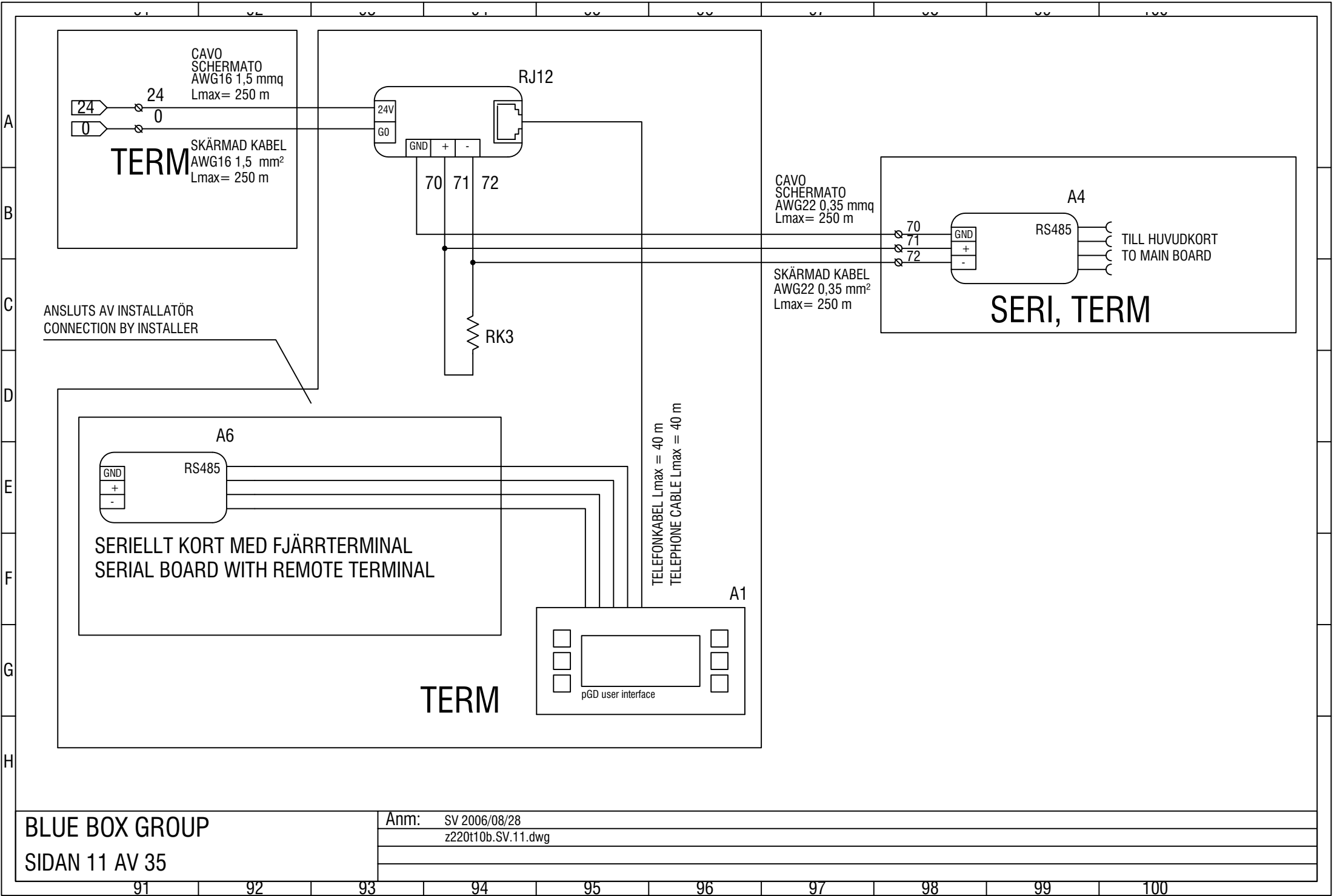

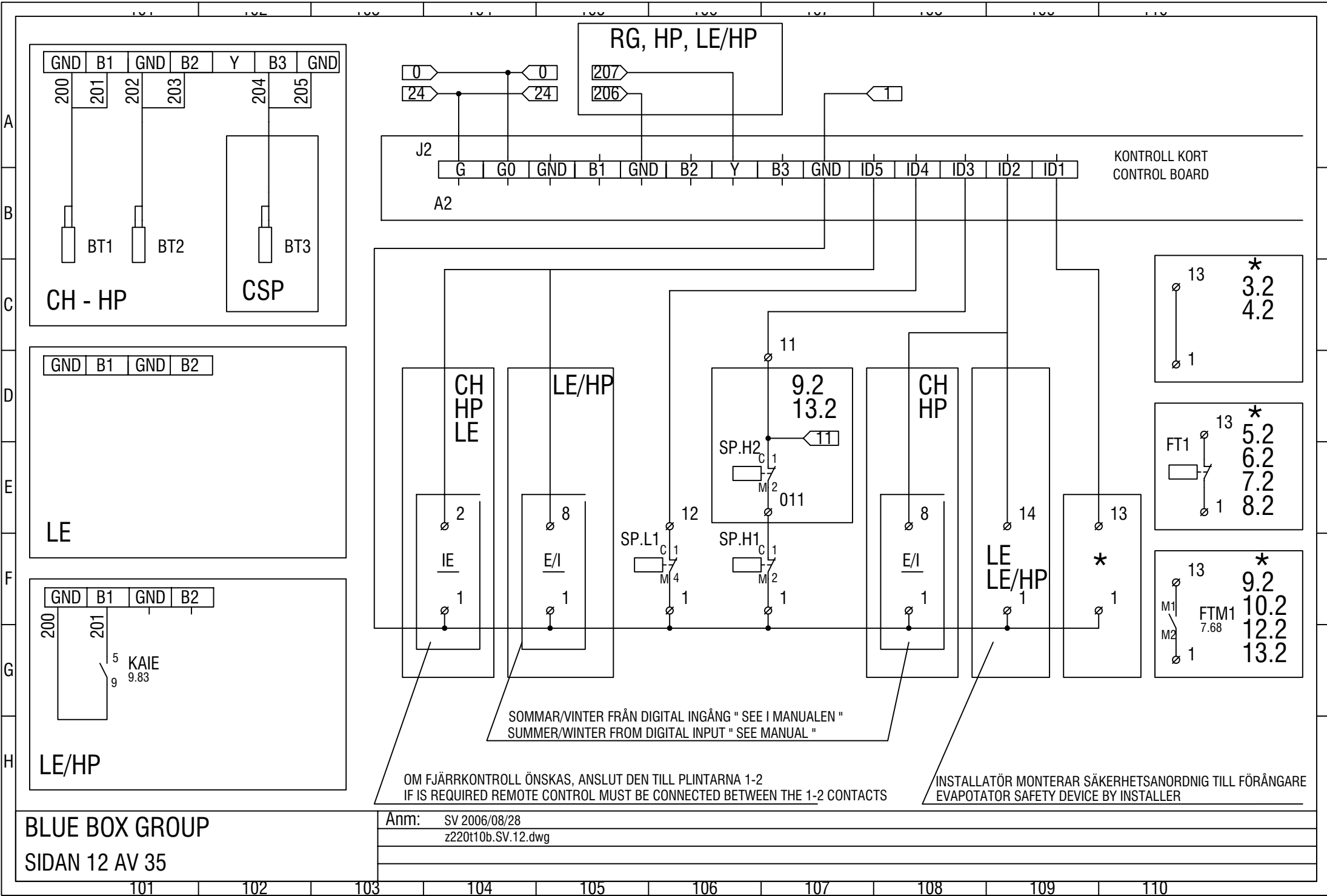

BLUE BOX GROUP
SIDAN 12 AV 35

Anm: SV 2006/08/28
z220t10b.SV.12.dwg

A
B
C
D
E
F
G
H

101 102 103 104 105 106 107 108 109 110

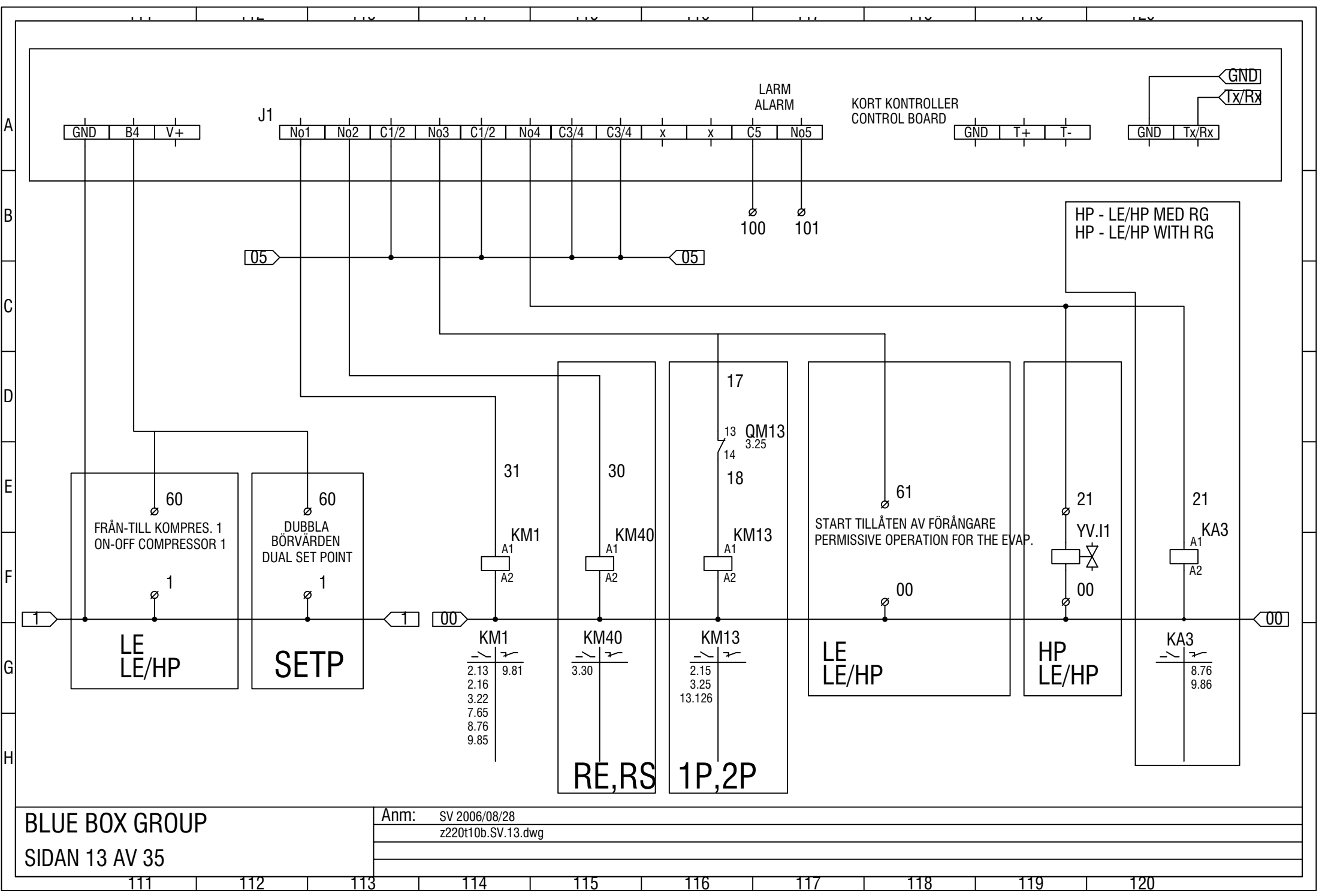

BLUE BOX GROUP
SIDAN 13 AV 35

Anm: SV 2006/08/28
z220t10b.SV.13.dwg

2.13	9.81
2.16	
3.22	
7.65	
8.76	
9.85	

3.30	
------	--

2.15	
3.25	
13.126	

8.76	
9.86	

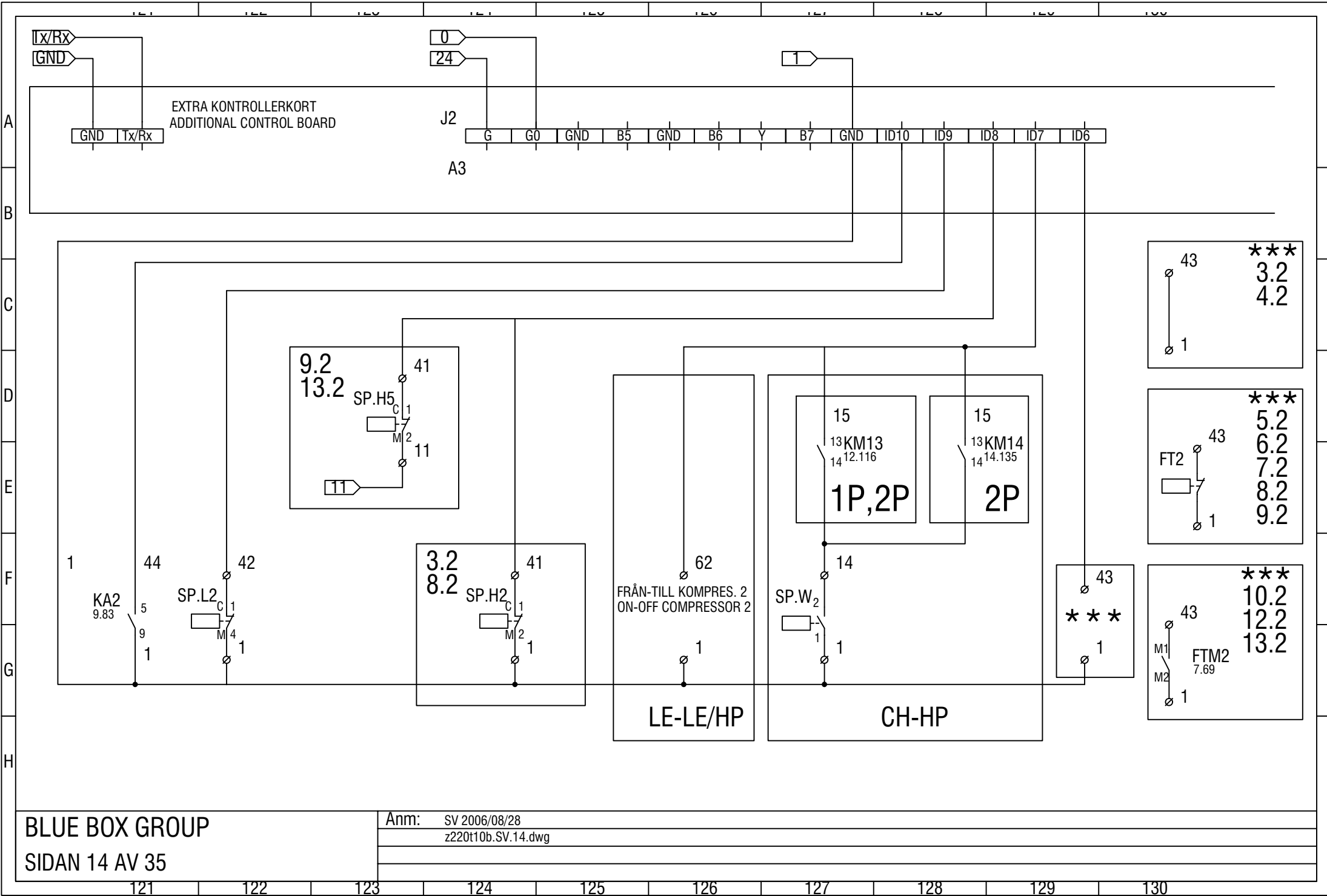

BLUE BOX GROUP
SIDAN 14 AV 35

Anm: SV 2006/08/28
z220t10b.SV.14.dwg

KOMPONENTER FÖR LE- ENHETER

Ref.	Beskrivning	Description	Typ/Type	Tillv./Manuf.
A1	FJÄRR TERMINAL	REMOTE TERMINAL	MCH200TW00	CAREL
A2	KONTROLL KORT 1	CONTROL BOARD 1	CH2000001	CAREL
A3	EXTRA KONTROLL KORT	ADDITIONAL CONTROL BOARD	MCH2000021	CAREL
A38	DUBBLA BÖRVÄRDEN TEMP.	DUAL SET POINTTHERM.	RTA200B230	CAREL
A4	SERIELLT KORT	SERIAL BOARD	MCH2004850	CAREL
A5	STEGLÖS FLÄKTREGLERING	FAN SPEED CONTROL	VRMMS 8	FAE
A6	SERIELLT KORT	SERIAL BOARD	MCH200TSV0	CAREL
BPH1	TRYCK SIGNALOMV.1	PRESSURE TRANSDUCER 1	SPKT0033R0	CAREL
BT38	GIVARE INKOMMANDE	INLET USER PROBE	NTC	CAREL
FU.L	SÄKRING INKOM. MATNING	SUPPLY FUSES		
FU1	SÄKRING KOMPRESSOR 1	COMPRESSOR 1 FUSES	CH10gG 20A	WEBER
FU2	SÄKRING KOMPRESSOR 2	COMPRESSOR 2 FUSES	CH10gG 20A	WEBER
FU50	SÄKRING TRANSFORMATOR TC	AUX.TRANSF.CIRCUIT FUSES	CH10gG 4A	WEBER
FU51	SÄKRING MANÖVERKRETS 230V	AUX. CIRCUIT FUSE	CH10gG 2A	WEBER
FU52	SÄKRING MANÖVERKRETS 24V	CONTROL FUSE	CH10gG 4A	WEBER
FU56	SÄKRING FASFÖLJDSRELÄ	PHASE SEQ.RELAY FUSES	CH10gG 2A	WEBER
IE	EXTERN MANÖVER	EXTERNE INTERLOCK		
IV	FÖRREG.1 KONDENSORFLÄKT.	FANS INTERLOCK		
KA1	SPÄNNINGSRELÄ	VOLTAGE RELAY	RMIA210230AC	GAVAZZI
KA2	RELÄ FLÄKTLARM	FAN ALARM RELAY	RMIA45230AC	GAVAZZI
KA5	RELÄ FASFÖLJD	PHASE SEQUENCE RELAY	DPA01CM44	GAVAZZI
KM1	KONTAKTOR KOMPRESSOR 1	COMPRESSOR 1 CONTACTOR	LS 27 220V	AEG
KM2	KONTAKTOR KOMPRESSOR 2	COMPRESSOR 2 CONTACTOR	LS 27 220V	AEG
KM21	KONTAKT. 1 KONDENSORFLÄKT	FANS CONTACTOR	LS 4 220V	AEG
M1	KOMPRESSOR 1	COMPRESSOR 1	SZ 90	MANEUROP
M2	KOMPRESSOR 2	COMPRESSOR 2	SZ 90	MANEUROP
M21	FLÄKT	FAN	2 X 0,59 kW	
QS	HUVUDSTRÖMBRYTARE	MAIN SWITCH	SIRCO 4X80	SOCOMEK
R1	ELVÄRME KOMPR. 1	CRANKCASE HEATER COMP.1	65 W	MANEUROP
R2	ELVÄRME KOMPR. 1	CRANKCASE HEATER COMP.2	65 W	MANEUROP
RK3	ELVÄRME KONTOLLER	CONTROL ELECTRIC HEATER	120 OHM	
SP.H1	HÖGTRYCKSVAKT 1	HIGH PRESSURE SWITCH 1		
SP.H5	HÖGTRYCKSVAKT 2	HIGH PRESSURE SWITCH 2		
SP.L1	LÅGTRYCKSVAKT 1	LOW PRESSURE SWITCH 1		
SP.L2	LÅGTRYCKSVAKT 2	LOW PRESSURE SWITCH 2		
TC1	TRANSFORMATOR MANÖVER	AUX.TRANSFORMER	300 VA	
TC2	TRANSFORMATOR TERMINAL	TERMINAL TRANSFORMER	TRADR4W024	CAREL
YV.A1	MAGNETVENTIL 1 HÖG TEMP	HIGH TEMP.SOL.VALVE 1	L 30 220V	RANCO
YV.F1	MAGNETVENTIL 1 LÅG TEMP	LOW TEMP.SOL.VALVE 1	HM2 220V	CASTEL
YV.L1	MAGNETVENTIL 1	SOLENOID VALVE 1	HM2 220V	CASTEL
YV.M1	MAGNETVENTIL FÖRÅNGARE 1	EVAP.CONTROL VALVE 1	HM2 220V	CASTEL
YV.S1	MAGNETVENTIL INSPRUTNING 1	INJECTION SOL.VALVE 1	HM2 220V	CASTEL

TILLÄGG AV KOMPONENTER FÖR LE/HP ENHETER - COMPONENTS TO BE ADDED FOR LE/HP UNITS

A10	FRÅN/TILL FLÄKT STYRNING	ON/OFF FAN DRIVER	CONVONOFF0	CAREL
A13	TERMOSTAT BATTERI	BATTERY THERMOSTAT	RTA200B230	CAREL
BT13	GIVARE BATTERI	BATTERY PROBE	NTC	CAREL
E/I	EXTERN MANÖVER SOMMAR/VINTER	SUMMER/WINTER		
KA3	RELÄ VÄRMEPUMP (HP)	HP RELAY	RMIA45230AC	GAVAZZI
KAIE	RELÄ FRÅN/TILL	ON-OFF RELAY	RMIA45230AC	GAVAZZI
KM22	KONTAKTOR FLÄKTAR	FANS CONTACTOR	LS 4 220V	AEG
KM23	KONTAKTOR FLÄKTAR	FANS CONTACTOR	LS 4 220V	AEG
SP.C1	DEFR. TRYCKVAKT 1	DEFR. PRESS.SWITCH 1	016-H6750.B01	RANCO
YV.I1	4-VÄGS VENTIL 1	4 WAY SOLENOID VALVE 1	L 30 220V	RANCO
YV.L5	MAGNETVENTIL 5	SOLENOID VALVE 5	HM2 220V	CASTEL

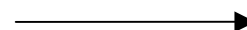

TILLÄGG AV KOMPONENTER FÖR VÄTSKEKYLAGGREGAT CH ENHETER - COMPONENTS TO BE ADDED FOR CH UNITS

Ref.	Beskrivning	Description	Typ/Type	Tillv./Manuf.
BT1	GIVARE INKOMMANDE	INLET USER PROBE	NTC	CAREL
BT2	GIVARE UTGÅENDE	OUTLET USER PROBE	NTC	CAREL
BT3	GIVARE, RETURLUFT	EXTERNAL AIR PROBE	NTC	CAREL
FU40	SÄKRINGAR ELVÄRMEKRETS	HEATER CIRCUIT FUSES	CH10gG 10A	WEBER
KM13	KONTAKTOR PUMP 1	PUMP 1 CONTACTOR	LS 4 220V	AEG
KM14	KONTAKTOR PUMP 2	PUMP 2 CONTACTOR	LS 4 220V	AEG
KM40	KONTAKTOR ELVÄRME FÖRÅNGARE	EVAP.ELECT.HEAT.CONTACTOR	LS 4 220V	AEG
M13	PUMP 1	PUMP 1	0,9 kW	
M14	PUMP 2	PUMP 2	0,9 kW	
QM13	MOTORSKYDD PUMP 1	PUMP MOTOR PROTECTION 1	MBS 25 2,5/4	AEG
QM14	MOTORSKYDD PUMP 2	PUMP MOTOR PROTECTION 2	MBS 25 2,5/4	AEG
R10	ELVÄRME TANK	TANK ELECT.HEATER	300 W	IRCA
R5	ELVÄRME FÖRÅNGARE 1	EVAP.ELECT.HEATER 1	170 W	RICA
R9	ELVÄRME VATTENKRETS	HYDRAULIC CIRC.HEATER	240 W	FER
SP.W	FLÖDESVAKT	FLOW SWITCH		

TILLKOMMANDE KOMPONENTER FÖR VÄRMEPUMPS-UTFÖRANDE (HP)- COMPONENTS TO BE ADDED FOR HP UNITS

A10	PÅ/AV FLÄKT STYRNING	ON/OFF FAN DRIVER	CONVONOFF0	CAREL
A13	TERMOSTAT BATTERI	BATTERY THERMOSTAT	RTA200B230	CAREL
BPH1	TRYCK SIGNALOMV.1	PRESSURE TRANSDUCER 1	SPKT0033R0	CAREL
BT1	GIVARE INKOMMANDE	INLET USER PROBE	NTC	CAREL
BT13	GIVARE BATTERI	BATTERY PROBE	NTC	CAREL
BT2	GIVARE UTGÅENDE	OUTLET USER PROBE	NTC	CAREL
BT3	GIVARE, RETURLUFT	EXTERNAL AIR PROBE	NTC	CAREL
E/1	EXTERN MANÖVER SOMMAR/VINTER	SUMMER/WINTER		
FU40	SÄKRING ELVÄRMEKRETS	HEATER CIRCUIT FUSES	CH10gG 10A	WEBER
KA3	RELÄ VÄRMEPUMP (HP)	HP RELAY	RMIA45230AC	GAVAZZI
KM13	KONTAKTOR PUMP 1	PUMP 1 CONTACTOR	LS 4 220V	AEG
KM14	KONTAKTOR PUMP 2	PUMP 2 CONTACTOR	LS 4 220V	AEG
KM22	KONTAKTOR FLÄKTAR	FANS CONTACTOR	LS 4 220V	AEG
KM23	KONTAKTOR FLÄKTAR	FANS CONTACTOR	LS 4 220V	AEG
KM40	KONTAKTOR ELVÄRME FÖRÅNGARE	EVAP.ELECT.HEAT.CONTACTOR	LS 4 220V	AEG
M13	PUMP 1	PUMP 1	0,9 kW	
M14	PUMP 2	PUMP 2	0,9 kW	
QM13	MOTORSKYDD PUMP 1	PUMP MOTOR PROTECTION 1	MBS 25 2,5/4	AEG
QM14	MOTORSKYDD PUMP 2	PUMP MOTOR PROTECTION 2	MBS 25 2,5/4	AEG
R10	ELVÄRME TANK	TANK ELECT.HEATER	300 W	IRCA
R5	ELVÄRME FÖRÅNGARE 1	EVAP.ELECT.HEATER 1	170 W	RICA
R9	ELVÄRME VATTENKRETS	HYDRAULIC CIRC.HEATER	240 W	FER
SP.C1	DEFR. TRYCKVAKT 1	DEFR. PRESS.SWITCH 1	016-H6750.B01	RANCO
SP.W	FLÖDESVAKT	FLOW SWITCH		
YV.I1	4-VÄGS VENTIL 1	4 WAY SOLENOID VALVE 1	L 30 220V	RANCO
YV.L1	MAGNETVENTIL 1	SOLENOID VALVE 1	HM2 220V	CASTEL

TILLKOMMANDE KOMPONENTER FÖR AGGREGAT MED REDUCERAD PUMP - REDUCED PUMPS

KM13	KONTAKTOR REDUCERAD PUMP 1	REDUCED PUMP 1 CONTACTOR	LS 4 220V	AEG
KM14	KONTAKTOR REDUCERAD PUMP 2	REDUCED PUMP 2 CONTACTOR	LS 4 220V	AEG
M13	REDUCERAD PUMP 1	REDUCED PUMPS 1	0,55 kW	
M14	REDUCERAD PUMP 2	REDUCED PUMPS 2	0,55 kW	
QM13	MOTORSKYDD REDUCERAD PUMP 1	REDUC. PUMP MOTOR PROTEC.1	MBS 25 1,6/2,5	AEG
QM14	MOTORSKYDD REDUCERAD PUMP 2	REDUC. PUMP MOTOR PROTEC.2	MBS 25 1,6/2,5	AEG

TILLKOMMANDE KOMPONENTER FÖR AGGREGAT MED ÖVERDIMENSIONERAD PUMP - OVERSIZED PUMPS

KM13	KONTAKTOR ÖVERDIM. PUMP 1	OVERSIZED PUMP 1 CONTACTOR	LS 4 220V	AEG
KM14	KONTAKTOR ÖVERDIM. PUMP 2	OVERSIZED PUMP 2 CONTACTOR	LS 4 220V	AEG
M13	ÖVERDIMENSIONERAD PUMP 1	OVERSIZED PUMPS 1	1,1 kW	
M14	ÖVERDIMENSIONERAD PUMP 2	OVERSIZED PUMPS 2	1,1 kW	
QM13	MOTORSKYDD ÖVERDIM. PUMP 1	OVERSIZED PUMP MOTOR PROTEC.1	MBS 25 2,5/4	AEG
QM14	MOTORSKYDD ÖVERDIM. PUMP 2	OVERSIZED PUMP MOTOR PROTEC.2	MBS 25 2,5/4	AEG

KOMPONENTER FÖR LE- ENHETER

Ref.	Beskrivning	Description	Typ/Type	Tillv./Manuf.
A1	FJÄRR TERMINAL	REMOTE TERMINAL	MCH200TW00	CAREL
A2	KONTROLL KORT 1	CONTROL BOARD 1	CH2000001	CAREL
A3	EXTRA KONTROLL KORT	ADDITIONAL CONTROL BOARD	MCH2000021	CAREL
A38	DUBBLA BÖRVÄRDEN TEMP.	DUAL SET POINTTHERM.	RTA200B230	CAREL
A4	SERIELLT KORT	SERIAL BOARD	MCH2004850	CAREL
A5	STEGLÖS FLÄKTREGLERING	FAN SPEED CONTROL	VRMMS 8	FAE
A6	SERIELLT KORT	SERIAL BOARD	MCH200TSV0	CAREL
BPH1	TRYCK SIGNALOMV.1	PRESSURE TRANSDUCER 1	SPKT0033R0	CAREL
BT38	GIVARE INKOMMANDE	INLET USER PROBE	NTC	CAREL
FU.L	SÄKRING INKOM. MATNING	SUPPLY FUSES		
FU1	SÄKRING KOMPRESSOR 1	COMPRESSOR 1 FUSES	CH10gG 25A	WEBER
FU2	SÄKRING KOMPRESSOR 2	COMPRESSOR 2 FUSES	CH10gG 25A	WEBER
FU50	SÄKRING TRANSFORMATOR TC	AUX.TRANSF.CIRCUIT FUSES	CH10gG 8A	WEBER
FU51	SÄKRING MANÖVERKRETS 230V	AUX. CIRCUIT FUSE	CH10gG 2A	WEBER
FU52	SÄKRING MANÖVERKRETS 24V	CONTROL FUSE	CH10gG 4A	WEBER
FU56	SÄKRING FASFÖLJDSRELÄ	PHASE SEQ.RELAY FUSES	CH10gG 2A	WEBER
IE	EXTERN MANÖVER	EXTERNE INTERLOCK		
IV	FÖRREG.1 KONDENSORFLÄKT.	FANS INTERLOCK		
KA1	SPÄNNINGSRELÄ	VOLTAGE RELAY	RMIA210230AC	GAVAZZI
KA2	RELÄ FLÄKTLARM	FAN ALARM RELAY	RMIA45230AC	GAVAZZI
KA5	RELÄ FASFÖLJD	PHASE SEQUENCE RELAY	DPA01CM44	GAVAZZI
KM1	KONTAKTOR KOMPRESSOR 1	COMPRESSOR 1 CONTACTOR	LS 27 220V	AEG
KM2	KONTAKTOR KOMPRESSOR 2	COMPRESSOR 2 CONTACTOR	LS 27 220V	AEG
KM21	KONTAKT. 1 KONDENSORFLÄKT	FANS CONTACTOR	LS 4 220V	AEG
M1	KOMPRESSOR 1	COMPRESSOR 1	SZ 110	MANEUROP
M2	KOMPRESSOR 2	COMPRESSOR 2	SZ 110	MANEUROP
M21	FLÄKT	FAN	2 X 0,59 kW	
QS	HUVUDSTRÖMBRYTARE	MAIN SWITCH	SIRCO 4X80	SOCOMEK
R1	ELVÄRME KOMPR. 1	CRANKCASE HEATER COMP.1	65 W	MANEUROP
R2	ELVÄRME KOMPR. 1	CRANKCASE HEATER COMP.2	65 W	MANEUROP
RK3	ELVÄRME KONTOLLER	CONTROL ELECTRIC HEATER	120 OHM	
SP.H1	HÖGTRYCKSVAKT 1	HIGH PRESSURE SWITCH 1		
SP.H5	HÖGTRYCKSVAKT 2	HIGH PRESSURE SWITCH 2		
SP.L1	LÅGTRYCKSVAKT 1	LOW PRESSURE SWITCH 1		
SP.L2	LÅGTRYCKSVAKT 2	LOW PRESSURE SWITCH 2		
TC1	TRANSFORMATOR MANÖVER	AUX.TRANSFORMER	300 VA	
TC2	TRANSFORMATOR TERMINAL	TERMINAL TRANSFORMER	TRADR4W024	CAREL
YV.A1	MAGNETVENTIL 1 HÖG TEMP	HIGH TEMP.SOL.VALVE 1	L 30 220V	RANCO
YV.F1	MAGNETVENTIL 1 LÅG TEMP	LOW TEMP.SOL.VALVE 1	HM2 220V	CASTEL
YV.L1	MAGNETVENTIL 1	SOLENOID VALVE 1	HM2 220V	CASTEL
YV.M1	MAGNETVENTIL FÖRÅNGARE 1	EVAP.CONTROL VALVE 1	HM2 220V	CASTEL
YV.S1	MAGNETVENTIL INSPRUTNING 1	INJECTION SOL.VALVE 1	HM2 220V	CASTEL

TILLÄGG AV KOMPONENTER FÖR LE/HP ENHETER - COMPONENTS TO BE ADDED FOR LE/HP UNITS

A10	FRÅN/TILL FLÄKT STYRNING	ON/OFF FAN DRIVER	CONVONOFF0	CAREL
A13	TERMOSTAT BATTERI	BATTERY THERMOSTAT	RTA200B230	CAREL
BT13	GIVARE BATTERI	BATTERY PROBE	NTC	CAREL
E/I	EXTERN MANÖVER SOMMAR/VINTER	SUMMER/WINTER		
KA3	RELÄ VÄRMEPUMP (HP)	HP RELAY	RMIA45230AC	GAVAZZI
KAIE	RELÄ FRÅN/TILL	ON-OFF RELAY	RMIA45230AC	GAVAZZI
KM22	KONTAKTOR FLÄKTAR	FANS CONTACTOR	LS 4 220V	AEG
KM23	KONTAKTOR FLÄKTAR	FANS CONTACTOR	LS 4 220V	AEG
SP.C1	DEFR. TRYCKVAKT 1	DEFR. PRESS.SWITCH 1	016-H6750.B01	RANCO
YV.I1	4-VÄGS VENTIL 1	4 WAY SOLENOID VALVE 1	L 30 220V	RANCO
YV.L5	MAGNETVENTIL 5	SOLENOID VALVE 5	HM2 220V	CASTEL

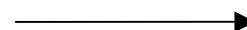

TILLÄGG AV KOMPONENTER FÖR VÄTSKEKYLAGGREGAT CH ENHETER - COMPONENTS TO BE ADDED FOR CH UNITS

Ref.	Beskrivning	Description	Typ/Type	Tillv./Manuf.
BT1	GIVARE INKOMMANDE	INLET USER PROBE	NTC	CAREL
BT2	GIVARE UTGÅENDE	OUTLET USER PROBE	NTC	CAREL
BT3	GIVARE, RETURLUFT	EXTERNAL AIR PROBE	NTC	CAREL
FU40	SÄKRINGAR ELVÄRMEKRETS	HEATER CIRCUIT FUSES	CH10gG 10A	WEBER
KM13	KONTAKTOR PUMP 1	PUMP 1 CONTACTOR	LS 4 220V	AEG
KM14	KONTAKTOR PUMP 2	PUMP 2 CONTACTOR	LS 4 220V	AEG
KM40	KONTAKTOR ELVÄRME FÖRÅNGARE	EVAP.ELECT.HEAT.CONTACTOR	LS 4 220V	AEG
M13	PUMP 1	PUMP 1	0,9 kW	
M14	PUMP 2	PUMP 2	0,9 kW	
QM13	MOTORSKYDD PUMP 1	PUMP MOTOR PROTECTION 1	MBS 25 2,5/4	AEG
QM14	MOTORSKYDD PUMP 2	PUMP MOTOR PROTECTION 2	MBS 25 2,5/4	AEG
R10	ELVÄRME TANK	TANK ELECT.HEATER	300 W	IRCA
R5	ELVÄRME FÖRÅNGARE 1	EVAP.ELECT.HEATER 1	170 W	RICA
R9	ELVÄRME VATTENKRETS	HYDRAULIC CIRC.HEATER	240 W	FER
SP.W	FLÖDESVAKT	FLOW SWITCH		

TILLKOMMANDE KOMPONENTER FÖR VÄRMEPUMPS-UTFÖRANDE (HP)- COMPONENTS TO BE ADDED FOR HP UNITS

A10	PÅ/AV FLÄKT STYRNING	ON/OFF FAN DRIVER	CONVONOFF0	CAREL
A13	TERMOSTAT BATTERI	BATTERY THERMOSTAT	RTA200B230	CAREL
BPH1	TRYCK SIGNALOMV.1	PRESSURE TRANSDUCER 1	SPKT0033R0	CAREL
BT1	GIVARE INKOMMANDE	INLET USER PROBE	NTC	CAREL
BT13	GIVARE BATTERI	BATTERY PROBE	NTC	CAREL
BT2	GIVARE UTGÅENDE	OUTLET USER PROBE	NTC	CAREL
BT3	GIVARE, RETURLUFT	EXTERNAL AIR PROBE	NTC	CAREL
E/1	EXTERN MANÖVER SOMMAR/VINTER	SUMMER/WINTER		
FU40	SÄKRING ELVÄRMEKRETS	HEATER CIRCUIT FUSES	CH10gG 10A	WEBER
KA3	RELÄ VÄRMEPUMP (HP)	HP RELAY	RMIA45230AC	GAVAZZI
KM13	KONTAKTOR PUMP 1	PUMP 1 CONTACTOR	LS 4 220V	AEG
KM14	KONTAKTOR PUMP 2	PUMP 2 CONTACTOR	LS 4 220V	AEG
KM22	KONTAKTOR FLÄKTAR	FANS CONTACTOR	LS 4 220V	AEG
KM23	KONTAKTOR FLÄKTAR	FANS CONTACTOR	LS 4 220V	AEG
KM40	KONTAKTOR ELVÄRME FÖRÅNGARE	EVAP.ELECT.HEAT.CONTACTOR	LS 4 220V	AEG
M13	PUMP 1	PUMP 1	0,9 kW	
M14	PUMP 2	PUMP 2	0,9 kW	
QM13	MOTORSKYDD PUMP 1	PUMP MOTOR PROTECTION 1	MBS 25 2,5/4	AEG
QM14	MOTORSKYDD PUMP 2	PUMP MOTOR PROTECTION 2	MBS 25 2,5/4	AEG
R10	ELVÄRME TANK	TANK ELECT.HEATER	300 W	IRCA
R5	ELVÄRME FÖRÅNGARE 1	EVAP.ELECT.HEATER 1	170 W	RICA
R9	ELVÄRME VATTENKRETS	HYDRAULIC CIRC.HEATER	240 W	FER
SP.C1	DEFR. TRYCKVAKT 1	DEFR. PRESS.SWITCH 1	016-H6750.B01	RANCO
SP.W	FLÖDESVAKT	FLOW SWITCH		
YV.I1	4-VÄGS VENTIL 1	4 WAY SOLENOID VALVE 1	L 30 220V	RANCO
YV.L1	MAGNETVENTIL 1	SOLENOID VALVE 1	HM2 220V	CASTEL

TILLKOMMANDE KOMPONENTER FÖR AGGREGAT MED REDUCERAD PUMP - REDUCED PUMPS

KM13	KONTAKTOR REDUCERAD PUMP 1	REDUCED PUMP 1 CONTACTOR	LS 4 220V	AEG
KM14	KONTAKTOR REDUCERAD PUMP 2	REDUCED PUMP 2 CONTACTOR	LS 4 220V	AEG
M13	REDUCERAD PUMP 1	REDUCED PUMPS 1	0,55 kW	
M14	REDUCERAD PUMP 2	REDUCED PUMPS 2	0,55 kW	
QM13	MOTORSKYDD REDUCERAD PUMP 1	REDUC. PUMP MOTOR PROTEC.1	MBS 25 1,6/2,5	AEG
QM14	MOTORSKYDD REDUCERAD PUMP 2	REDUC. PUMP MOTOR PROTEC.2	MBS 25 1,6/2,5	AEG

TILLKOMMANDE KOMPONENTER FÖR AGGREGAT MED ÖVERDIMENSIONERAD PUMP - OVERSIZED PUMPS

KM13	KONTAKTOR ÖVERDIM. PUMP 1	OVERSIZED PUMP 1 CONTACTOR	LS 4 220V	AEG
KM14	KONTAKTOR ÖVERDIM. PUMP 2	OVERSIZED PUMP 2 CONTACTOR	LS 4 220V	AEG
M13	ÖVERDIMENSIONERAD PUMP 1	OVERSIZED PUMPS 1	1,1 kW	
M14	ÖVERDIMENSIONERAD PUMP 2	OVERSIZED PUMPS 2	1,1 kW	
QM13	MOTORSKYDD ÖVERDIM. PUMP 1	OVERSIZED PUMP MOTOR PROTEC.1	MBS 25 2,5/4	AEG
QM14	MOTORSKYDD ÖVERDIM. PUMP 2	OVERSIZED PUMP MOTOR PROTEC.2	MBS 25 2,5/4	AEG

KOMPONENTER FÖR LE- ENHETER

Ref.	Beskrivning	Description	Typ/Type	Tillv./Manuf.
A1	FJÄRR TERMINAL	REMOTE TERMINAL	MCH200TW00	CAREL
A2	KONTROLL KORT 1	CONTROL BOARD 1	CH2000001	CAREL
A3	EXTRA KONTROLL KORT	ADDITIONAL CONTROL BOARD	MCH2000021	CAREL
A38	DUBBLA BÖRVÄRDEN TEMP.	DUAL SET POINTTHERM.	RTA200B230	CAREL
A4	SERIELLT KORT	SERIAL BOARD	MCH2004850	CAREL
A5	STEGLÖS FLÄKTREGLERING	FAN SPEED CONTROL	VRMMS 8	FAE
A6	SERIELLT KORT	SERIAL BOARD	MCH200TSV0	CAREL
BPH1	TRYCK SIGNALOMV.1	PRESSURE TRANSDUCER 1	SPKT0033R0	CAREL
BT38	GIVARE INKOMMANDE	INLET USER PROBE	NTC	CAREL
FT1	Klixon 1	KLICKSON 1		
FT2	Klixon 2	KLICKSON 2		
FU.L	SÄKRING INKOM. MATNING	SUPPLY FUSES		
FU1	SÄKRING KOMPRESSOR 1	COMPRESSOR 1 FUSES	CH10gG 25A	WEBER
FU2	SÄKRING KOMPRESSOR 2	COMPRESSOR 2 FUSES	CH10gG 25A	WEBER
FU50	SÄKRING TRANSFORMATOR TC	AUX.TRANSF.CIRCUIT FUSES	CH10gG 8A	WEBER
FU51	SÄKRING MANÖVERKRETS 230V	AUX. CIRCUIT FUSE	CH10gG 2A	WEBER
FU52	SÄKRING MANÖVERKRETS 24V	CONTROL FUSE	CH10gG 4A	WEBER
FU56	SÄKRING FASFÖLJDSRELÄ	PHASE SEQ.RELAY FUSES	CH10gG 2A	WEBER
IE	EXTERN MANÖVER	EXTERNE INTERLOCK		
IV	FÖRREG.1 KONDENSORFLÄKT.	FANS INTERLOCK		
KA1	SPÄNNINGSRELÄ	VOLTAGE RELAY	RMIA210230AC	GAVAZZI
KA2	RELÄ FLÄKTLARM	FAN ALARM RELAY	RMIA45230AC	GAVAZZI
KA5	RELÄ FASFÖLJD	PHASE SEQUENCE RELAY	DPA01CM44	GAVAZZI
KM1	KONTAKTOR KOMPRESSOR 1	COMPRESSOR 1 CONTACTOR	LS 37 220V	AEG
KM2	KONTAKTOR KOMPRESSOR 2	COMPRESSOR 2 CONTACTOR	LS 37 220V	AEG
KM21	KONTAKT. 1 KONDENSORFLÄKT	FANS CONTACTOR	LS 4 220V	AEG
M1	KOMPRESSOR 1	COMPRESSOR 1	SZ 125	MANEUROP
M2	KOMPRESSOR 2	COMPRESSOR 2	SZ 125	MANEUROP
M21	FLÄKT	FAN	2 X 0,59 kW	
QS	HUVUDSTRÖMBRYTARE	MAIN SWITCH	SIRCO 4X80	SOCOMEK
R1	ELVÄRME KOMPR. 1	CRANKCASE HEATER COMP.1	65 W	MANEUROP
R2	ELVÄRME KOMPR. 1	CRANKCASE HEATER COMP.2	65 W	MANEUROP
RK3	ELVÄRME KONTOLLER	CONTROL ELECTRIC HEATER	120 OHM	
SP.H1	HÖGTRYCKSVAKT 1	HIGH PRESSURE SWITCH 1		
SP.H5	HÖGTRYCKSVAKT 2	HIGH PRESSURE SWITCH 2		
SP.L1	LÅGTRYCKSVAKT 1	LOW PRESSURE SWITCH 1		
SP.L2	LÅGTRYCKSVAKT 2	LOW PRESSURE SWITCH 2		
TC1	TRANSFORMATOR MANÖVER	AUX.TRANSFORMER	300 VA	
TC2	TRANSFORMATOR TERMINAL	TERMINAL TRANSFORMER	TRADR4W024	CAREL
YV.A1	MAGNETVENTIL 1 HÖG TEMP	HIGH TEMP.SOL.VALVE 1	L 30 220V	RANCO
YV.F1	MAGNETVENTIL 1 LÅG TEMP	LOW TEMP.SOL.VALVE 1	HM2 220V	CASTEL
YV.L1	MAGNETVENTIL 1	SOLENOID VALVE 1	HM2 220V	CASTEL
YV.M1	MAGNETVENTIL FÖRÅNGARE 1	EVAP.CONTROL VALVE 1	HM2 220V	CASTEL
YV.S1	MAGNETVENTIL INSPRUTNING 1	INJECTION SOL.VALVE 1	HM2 220V	CASTEL

TILLÄGG AV KOMPONENTER FÖR LE/HP ENHETER - COMPONENTS TO BE ADDED FOR LE/HP UNITS

A10	FRÅN/TILL FLÄKT STYRNING	ON/OFF FAN DRIVER	CONVONOFF0	CAREL
A13	TERMOSTAT BATTERI	BATTERY THERMOSTAT	RTA200B230	CAREL
BT13	GIVARE BATTERI	BATTERY PROBE	NTC	CAREL
E/1	EXTERN MANÖVER SOMMAR/VINTER	SUMMER/WINTER		
KA3	RELÄ VÄRMEPUMP (HP)	HP RELAY	RMIA45230AC	GAVAZZI
KAIE	RELÄ FRÅN/TILL	ON-OFF RELAY	RMIA45230AC	GAVAZZI
KM22	KONTAKTOR FLÄKTAR	FANS CONTACTOR	LS 4 220V	AEG
KM23	KONTAKTOR FLÄKTAR	FANS CONTACTOR	LS 4 220V	AEG
SP.C1	DEFR. TRYCKVAKT 1	DEFR. PRESS.SWITCH 1	016-H6750.B01	RANCO
YV.I1	4-VÄGS VENTIL 1	4 WAY SOLENOID VALVE 1	L 30 220V	RANCO
YV.L5	MAGNETVENTIL 5	SOLENOID VALVE 5	HM2 220V	CASTEL

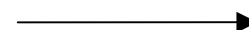

TILLÄGG AV KOMPONENTER FÖR VÄTSKEKYLAGGREGAT CH ENHETER - COMPONENTS TO BE ADDED FOR CH UNITS

Ref.	Beskrivning	Description	Typ/Type	Tillv./Manuf.
BT1	GIVARE INKOMMANDE	INLET USER PROBE	NTC	CAREL
BT2	GIVARE UTGÅENDE	OUTLET USER PROBE	NTC	CAREL
BT3	GIVARE, RETURLUFT	EXTERNAL AIR PROBE	NTC	CAREL
FU40	SÄKRINGAR ELVÄRMEKRETS	HEATER CIRCUIT FUSES	CH10gG 10A	WEBER
KM13	KONTAKTOR PUMP 1	PUMP 1 CONTACTOR	LS 4 220V	AEG
KM14	KONTAKTOR PUMP 2	PUMP 2 CONTACTOR	LS 4 220V	AEG
KM40	KONTAKTOR ELVÄRME FÖRÅNGARE	EVAP.ELECT.HEAT.CONTACTOR	LS 4 220V	AEG
M13	PUMP 1	PUMP 1	0,9 kW	
M14	PUMP 2	PUMP 2	0,9 kW	
QM13	MOTORSKYDD PUMP 1	PUMP MOTOR PROTECTION 1	MBS 25 2,5/4	AEG
QM14	MOTORSKYDD PUMP 2	PUMP MOTOR PROTECTION 2	MBS 25 2,5/4	AEG
R10	ELVÄRME TANK	TANK ELECT.HEATER	300 W	IRCA
R5	ELVÄRME FÖRÅNGARE 1	EVAP.ELECT.HEATER 1	170 W	RICA
R9	ELVÄRME VATTENKRETS	HYDRAULIC CIRC.HEATER	240 W	FER
SP.W	FLÖDESVAKT	FLOW SWITCH		

TILLKOMMANDE KOMPONENTER FÖR VÄRMEPUMPS-UTFÖRANDE (HP)- COMPONENTS TO BE ADDED FOR HP UNITS

A10	PÅ/AV FLÄKT STYRNING	ON/OFF FAN DRIVER	CONVONOFF0	CAREL
A13	TERMOSTAT BATTERI	BATTERY THERMOSTAT	RTA200B230	CAREL
BPH1	TRYCK SIGNALOMV.1	PRESSURE TRANSDUCER 1	SPKT0033R0	CAREL
BT1	GIVARE INKOMMANDE	INLET USER PROBE	NTC	CAREL
BT13	GIVARE BATTERI	BATTERY PROBE	NTC	CAREL
BT2	GIVARE UTGÅENDE	OUTLET USER PROBE	NTC	CAREL
BT3	GIVARE, RETURLUFT	EXTERNAL AIR PROBE	NTC	CAREL
E/1	EXTERN MANÖVER SOMMAR/VINTER	SUMMER/WINTER		
FU40	SÄKRING ELVÄRMEKRETS	HEATER CIRCUIT FUSES	CH10gG 10A	WEBER
KA3	RELÄ VÄRMEPUMP (HP)	HP RELAY	RMIA45230AC	GAVAZZI
KM13	KONTAKTOR PUMP 1	PUMP 1 CONTACTOR	LS 4 220V	AEG
KM14	KONTAKTOR PUMP 2	PUMP 2 CONTACTOR	LS 4 220V	AEG
KM22	KONTAKTOR FLÄKTAR	FANS CONTACTOR	LS 4 220V	AEG
KM23	KONTAKTOR FLÄKTAR	FANS CONTACTOR	LS 4 220V	AEG
KM40	KONTAKTOR ELVÄRME FÖRÅNGARE	EVAP.ELECT.HEAT.CONTACTOR	LS 4 220V	AEG
M13	PUMP 1	PUMP 1	0,9 kW	
M14	PUMP 2	PUMP 2	0,9 kW	
QM13	MOTORSKYDD PUMP 1	PUMP MOTOR PROTECTION 1	MBS 25 2,5/4	AEG
QM14	MOTORSKYDD PUMP 2	PUMP MOTOR PROTECTION 2	MBS 25 2,5/4	AEG
R10	ELVÄRME TANK	TANK ELECT.HEATER	300 W	IRCA
R5	ELVÄRME FÖRÅNGARE 1	EVAP.ELECT.HEATER 1	170 W	RICA
R9	ELVÄRME VATTENKRETS	HYDRAULIC CIRC.HEATER	240 W	FER
SP.C1	DEFR. TRYCKVAKT 1	DEFR. PRESS.SWITCH 1	016-H6750.B01	RANCO
SP.W	FLÖDESVAKT	FLOW SWITCH		
YV.I1	4-VÄGS VENTIL 1	4 WAY SOLENOID VALVE 1	L 30 220V	RANCO
YV.L1	MAGNETVENTIL 1	SOLENOID VALVE 1	HM2 220V	CASTEL

TILLKOMMANDE KOMPONENTER FÖR AGGREGAT MED REDUCERAD PUMP - REDUCED PUMPS

KM13	KONTAKTOR REDUCERAD PUMP 1	REDUCED PUMP 1 CONTACTOR	LS 4 220V	AEG
KM14	KONTAKTOR REDUCERAD PUMP 2	REDUCED PUMP 2 CONTACTOR	LS 4 220V	AEG
M13	REDUCERAD PUMP 1	REDUCED PUMPS 1	0,55 kW	
M14	REDUCERAD PUMP 2	REDUCED PUMPS 2	0,55 kW	
QM13	MOTORSKYDD REDUCERAD PUMP 1	REDUC. PUMP MOTOR PROTEC.1	MBS 25 1,6/2,5	AEG
QM14	MOTORSKYDD REDUCERAD PUMP 2	REDUC. PUMP MOTOR PROTEC.2	MBS 25 1,6/2,5	AEG

TILLKOMMANDE KOMPONENTER FÖR AGGREGAT MED ÖVERDIMENSIONERAD PUMP - OVERSIZED PUMPS

KM13	KONTAKTOR ÖVERDIM. PUMP 1	OVERSIZED PUMP 1 CONTACTOR	LS 4 220V	AEG
KM14	KONTAKTOR ÖVERDIM. PUMP 2	OVERSIZED PUMP 2 CONTACTOR	LS 4 220V	AEG
M13	ÖVERDIMENSIONERAD PUMP 1	OVERSIZED PUMPS 1	1,5 kW	
M14	ÖVERDIMENSIONERAD PUMP 2	OVERSIZED PUMPS 2	1,5 kW	
QM13	MOTORSKYDD ÖVERDIM. PUMP 1	OVERSIZED PUMP MOTOR PROTEC.1	MBS 25 2,5/4	AEG
QM14	MOTORSKYDD ÖVERDIM. PUMP 2	OVERSIZED PUMP MOTOR PROTEC.2	MBS 25 2,5/4	AEG

KOMPONENTER FÖR LE- ENHETER

Ref.	Beskrivning	Description	Typ/Type	Tillv./Manuf.
A1	FJÄRR TERMINAL	REMOTE TERMINAL	MCH200TW00	CAREL
A2	KONTROLL KORT 1	CONTROL BOARD 1	CH2000001	CAREL
A3	EXTRA KONTROLL KORT	ADDITIONAL CONTROL BOARD	MCH2000021	CAREL
A38	DUBBLA BÖRVÅRDEN TEMP.	DUAL SET POINTTHERM.	RTA200B230	CAREL
A4	SERIELLT KORT	SERIAL BOARD	MCH2004850	CAREL
A5	STEGLÖS FLÄKTREGLERING	FAN SPEED CONTROL	VRMMS 8	FAE
A6	SERIELLT KORT	SERIAL BOARD	MCH200TSV0	CAREL
BPH1	TRYCK SIGNALOMV.1	PRESSURE TRANSDUCER 1	SPKT0033R0	CAREL
BT38	GIVARE INKOMMANDE	INLET USER PROBE	NTC	CAREL
FT1	Klixon 1	KLICKSON 1		
FT2	Klixon 2	KLICKSON 2		
FU.L	SÄKRING INKOM. MATNING	SUPPLY FUSES		
FU1	SÄKRING KOMPRESSOR 1	COMPRESSOR 1 FUSES	CH14gG 40A	WEBER
FU2	SÄKRING KOMPRESSOR 2	COMPRESSOR 2 FUSES	CH10gG 25A	WEBER
FU50	SÄKRING TRANSFORMATOR TC	AUX.TRANSF.CIRCUIT FUSES	CH10gG 8A	WEBER
FU51	SÄKRING MANÖVERKRETS 230V	AUX. CIRCUIT FUSE	CH10gG 2A	WEBER
FU52	SÄKRING MANÖVERKRETS 24V	CONTROL FUSE	CH10gG 4A	WEBER
FU56	SÄKRING FASFÖLJDSRELÄ	PHASE SEQ.RELAY FUSES	CH10gG 2A	WEBER
IE	EXTERN MANÖVER	EXTERNE INTERLOCK		
IV	FÖRREG.1 KONDENSORFLÄKT.	FANS INTERLOCK		
KA1	SPÄNNINGSRELÄ	VOLTAGE RELAY	RMIA210230AC	GAVAZZI
KA2	RELÄ FLÄKTLARM	FAN ALARM RELAY	RMIA45230AC	GAVAZZI
KA5	RELÄ FASFÖLJD	PHASE SEQUENCE RELAY	DPA01CM44	GAVAZZI
KM1	KONTAKTOR KOMPRESSOR 1	COMPRESSOR 1 CONTACTOR	LS 47 220V	AEG
KM2	KONTAKTOR KOMPRESSOR 2	COMPRESSOR 2 CONTACTOR	LS 37 220V	AEG
KM21	KONTAKT. 1 KONDENSORFLÄKT	FANS CONTACTOR	LS 4 220V	AEG
M1	KOMPRESSOR 1	COMPRESSOR 1	SZ 160	MANEUROP
M2	KOMPRESSOR 2	COMPRESSOR 2	SZ 125	MANEUROP
M21	FLÄKT	FAN	2 X 0,59 kW	
QS	HUVUDSTRÖMBRYTARE	MAIN SWITCH	SIRCO 4X100	SOCOMEK
R1	ELVÄRME KOMPR. 1	CRANKCASE HEATER COMP.1	65 W	MANEUROP
R2	ELVÄRME KOMPR. 1	CRANKCASE HEATER COMP.2	65 W	MANEUROP
RK3	ELVÄRME KONTOLLER	CONTROL ELECTRIC HEATER	120 OHM	
SP.H1	HÖGTRYCKSVAKT 1	HIGH PRESSURE SWITCH 1		
SP.H5	HÖGTRYCKSVAKT 2	HIGH PRESSURE SWITCH 2		
SP.L1	LÅGTRYCKSVAKT 1	LOW PRESSURE SWITCH 1		
SP.L2	LÅGTRYCKSVAKT 2	LOW PRESSURE SWITCH 2		
TC1	TRANSFORMATOR MANÖVER	AUX.TRANSFORMER	300 VA	
TC2	TRANSFORMATOR TERMINAL	TERMINAL TRANSFORMER	TRADR4W024	CAREL
YV.A1	MAGNETVENTIL 1 HÖG TEMP	HIGH TEMP.SOL.VALVE 1	L 30 220V	RANCO
YV.F1	MAGNETVENTIL 1 LÅG TEMP	LOW TEMP.SOL.VALVE 1	HM2 220V	CASTEL
YV.L1	MAGNETVENTIL 1	SOLENOID VALVE 1	HM2 220V	CASTEL
YV.M1	MAGNETVENTIL FÖRÅNGARE 1	EVAP.CONTROL VALVE 1	HM2 220V	CASTEL
YV.S1	MAGNETVENTIL INSPRUTNING 1	INJECTION SOL.VALVE 1	HM2 220V	CASTEL

TILLÄGG AV KOMPONENTER FÖR LE/HP ENHETER - COMPONENTS TO BE ADDED FOR LE/HP UNITS

A10	FRÅN/TILL FLÄKT STYRNING	ON/OFF FAN DRIVER	CONVONOFF0	CAREL
A13	TERMOSTAT BATTERI	BATTERY THERMOSTAT	RTA200B230	CAREL
BT13	GIVARE BATTERI	BATTERY PROBE	NTC	CAREL
E/1	EXTERN MANÖVER SOMMAR/VINTER	SUMMER/WINTER		
KA3	RELÄ VÄRMEPUMP (HP)	HP RELAY	RMIA45230AC	GAVAZZI
KAIE	RELÄ FRÅN/TILL	ON-OFF RELAY	RMIA45230AC	GAVAZZI
KM22	KONTAKTOR FLÄKTAR	FANS CONTACTOR	LS 4 220V	AEG
KM23	KONTAKTOR FLÄKTAR	FANS CONTACTOR	LS 4 220V	AEG
SP.C1	DEFR. TRYCKVAKT 1	DEFR. PRESS.SWITCH 1	016-H6750.B01	RANCO
YV.I1	4-VÄGS VENTIL 1	4 WAY SOLENOID VALVE 1	L 30 220V	RANCO
YV.L5	MAGNETVENTIL 5	SOLENOID VALVE 5	HM2 220V	CASTEL

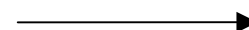

TILLÄGG AV KOMPONENTER FÖR VÄTSKEKYLAGGREGAT CH ENHETER - COMPONENTS TO BE ADDED FOR CH UNITS

Ref.	Beskrivning	Description	Typ/Type	Tillv./Manuf.
BT1	GIVARE INKOMMANDE	INLET USER PROBE	NTC	CAREL
BT2	GIVARE UTGÅENDE	OUTLET USER PROBE	NTC	CAREL
BT3	GIVARE, RETURLUFT	EXTERNAL AIR PROBE	NTC	CAREL
FU40	SÄKRINGAR ELVÄRMEKRETS	HEATER CIRCUIT FUSES	CH10gG 10A	WEBER
KM13	KONTAKTOR PUMP 1	PUMP 1 CONTACTOR	LS 4 220V	AEG
KM14	KONTAKTOR PUMP 2	PUMP 2 CONTACTOR	LS 4 220V	AEG
KM40	KONTAKTOR ELVÄRME FÖRÅNGARE	EVAP.ELECT.HEAT.CONTACTOR	LS 4 220V	AEG
M13	PUMP 1	PUMP 1	1,5 kW	
M14	PUMP 2	PUMP 2	1,5 kW	
QM13	MOTORSKYDD PUMP 1	PUMP MOTOR PROTECTION 1	MBS 25 2,5/4	AEG
QM14	MOTORSKYDD PUMP 2	PUMP MOTOR PROTECTION 2	MBS 25 2,5/4	AEG
R10	ELVÄRME TANK	TANK ELECT.HEATER	300 W	IRCA
R5	ELVÄRME FÖRÅNGARE 1	EVAP.ELECT.HEATER 1	170 W	RICA
R9	ELVÄRME VATTENKRETS	HYDRAULIC CIRC.HEATER	240 W	FER
SP.W	FLÖDESVAKT	FLOW SWITCH		

TILLKOMMANDE KOMPONENTER FÖR VÄRMEPUMPS-UTFÖRANDE (HP)- COMPONENTS TO BE ADDED FOR HP UNITS

A10	PÅ/AV FLÄKT STYRNING	ON/OFF FAN DRIVER	CONVONOFF0	CAREL
A13	TERMOSTAT BATTERI	BATTERY THERMOSTAT	RTA200B230	CAREL
BPH1	TRYCK SIGNALOMV.1	PRESSURE TRANSDUCER 1	SPKT0033R0	CAREL
BT1	GIVARE INKOMMANDE	INLET USER PROBE	NTC	CAREL
BT13	GIVARE BATTERI	BATTERY PROBE	NTC	CAREL
BT2	GIVARE UTGÅENDE	OUTLET USER PROBE	NTC	CAREL
BT3	GIVARE, RETURLUFT	EXTERNAL AIR PROBE	NTC	CAREL
E/1	EXTERN MANÖVER SOMMAR/VINTER	SUMMER/WINTER		
FU40	SÄKRING ELVÄRMEKRETS	HEATER CIRCUIT FUSES	CH10gG 10A	WEBER
KA3	RELÄ VÄRMEPUMP (HP)	HP RELAY	RMIA45230AC	GAVAZZI
KM13	KONTAKTOR PUMP 1	PUMP 1 CONTACTOR	LS 4 220V	AEG
KM14	KONTAKTOR PUMP 2	PUMP 2 CONTACTOR	LS 4 220V	AEG
KM22	KONTAKTOR FLÄKTAR	FANS CONTACTOR	LS 4 220V	AEG
KM23	KONTAKTOR FLÄKTAR	FANS CONTACTOR	LS 4 220V	AEG
KM40	KONTAKTOR ELVÄRME FÖRÅNGARE	EVAP.ELECT.HEAT.CONTACTOR	LS 4 220V	AEG
M13	PUMP 1	PUMP 1	1,5 kW	
M14	PUMP 2	PUMP 2	1,5 kW	
QM13	MOTORSKYDD PUMP 1	PUMP MOTOR PROTECTION 1	MBS 25 2,5/4	AEG
QM14	MOTORSKYDD PUMP 2	PUMP MOTOR PROTECTION 2	MBS 25 2,5/4	AEG
R10	ELVÄRME TANK	TANK ELECT.HEATER	300 W	IRCA
R5	ELVÄRME FÖRÅNGARE 1	EVAP.ELECT.HEATER 1	170 W	RICA
R9	ELVÄRME VATTENKRETS	HYDRAULIC CIRC.HEATER	240 W	FER
SP.C1	DEFR. TRYCKVAKT 1	DEFR. PRESS.SWITCH 1	016-H6750.B01	RANCO
SP.W	FLÖDESVAKT	FLOW SWITCH		
YV.I1	4-VÄGS VENTIL 1	4 WAY SOLENOID VALVE 1	L 30 220V	RANCO
YV.L1	MAGNETVENTIL 1	SOLENOID VALVE 1	HM2 220V	CASTEL

TILLKOMMANDE KOMPONENTER FÖR AGGREGAT MED REDUCERAD PUMP - REDUCED PUMPS

KM13	KONTAKTOR REDUCERAD PUMP 1	REDUCED PUMP 1 CONTACTOR	LS 4 220V	AEG
KM14	KONTAKTOR REDUCERAD PUMP 2	REDUCED PUMP 2 CONTACTOR	LS 4 220V	AEG
M13	REDUCERAD PUMP 1	REDUCED PUMPS 1	1,1 kW	
M14	REDUCERAD PUMP 2	REDUCED PUMPS 2	1,1 kW	
QM13	MOTORSKYDD REDUCERAD PUMP 1	REDUC. PUMP MOTOR PROTEC.1	MBS 25 2,5/4	AEG
QM14	MOTORSKYDD REDUCERAD PUMP 2	REDUC. PUMP MOTOR PROTEC.2	MBS 25 2,5/4	AEG

TILLKOMMANDE KOMPONENTER FÖR AGGREGAT MED ÖVERDIMENSIONERAD PUMP - OVERSIZED PUMPS

KM13	KONTAKTOR ÖVERDIM. PUMP 1	OVERSIZED PUMP 1 CONTACTOR	LS 4 220V	AEG
KM14	KONTAKTOR ÖVERDIM. PUMP 2	OVERSIZED PUMP 2 CONTACTOR	LS 4 220V	AEG
M13	ÖVERDIMENSIONERAD PUMP 1	OVERSIZED PUMPS 1	1,85 kW	
M14	ÖVERDIMENSIONERAD PUMP 2	OVERSIZED PUMPS 2	1,85 kW	
QM13	MOTORSKYDD ÖVERDIM. PUMP 1	OVERSIZED PUMP MOTOR PROTEC.1	MBS 25 4/6,3	AEG
QM14	MOTORSKYDD ÖVERDIM. PUMP 2	OVERSIZED PUMP MOTOR PROTEC.2	MBS 25 4/6,3	AEG

KOMPONENTER FÖR LE- ENHETER

Ref.	Beskrivning	Description	Typ/Type	Tillv./Manuf.
A1	FJÄRR TERMINAL	REMOTE TERMINAL	MCH200TW00	CAREL
A2	KONTROLL KORT 1	CONTROL BOARD 1	CH2000001	CAREL
A3	EXTRA KONTROLL KORT	ADDITIONAL CONTROL BOARD	MCH2000021	CAREL
A38	DUBBLA BÖRVÅRDEN TEMP.	DUAL SET POINTTHERM.	RTA200B230	CAREL
A4	SERIELLT KORT	SERIAL BOARD	MCH2004850	CAREL
A5	STEGLÖS FLÄKTREGLERING	FAN SPEED CONTROL	VRMMS 8	FAE
A6	SERIELLT KORT	SERIAL BOARD	MCH200TSV0	CAREL
BPH1	TRYCK SIGNALOMV.1	PRESSURE TRANSDUCER 1	SPKT0033R0	CAREL
BT38	GIVARE INKOMMANDE	INLET USER PROBE	NTC	CAREL
FT1	Klixon 1	KLICKSON 1		
FT2	Klixon 2	KLICKSON 2		
FU.L	SÄKRING INKOM. MATNING	SUPPLY FUSES		
FU1	SÄKRING KOMPRESSOR 1	COMPRESSOR 1 FUSES	CH14gG 40A	WEBER
FU2	SÄKRING KOMPRESSOR 2	COMPRESSOR 2 FUSES	CH14gG 40A	WEBER
FU50	SÄKRING TRANSFORMATOR TC	AUX.TRANSF.CIRCUIT FUSES	CH10gG 8A	WEBER
FU51	SÄKRING MANÖVERKRETS 230V	AUX. CIRCUIT FUSE	CH10gG 2A	WEBER
FU52	SÄKRING MANÖVERKRETS 24V	CONTROL FUSE	CH10gG 4A	WEBER
FU56	SÄKRING FASFÖLJDSRELÄ	PHASE SEQ.RELAY FUSES	CH10gG 2A	WEBER
IE	EXTERN MANÖVER	EXTERNE INTERLOCK		
IV	FÖRREG.1 KONDENSORFLÄKT.	FANS INTERLOCK		
KA1	SPÄNNINGSRELÄ	VOLTAGE RELAY	RMIA210230AC	GAVAZZI
KA2	RELÄ FLÄKTLARM	FAN ALARM RELAY	RMIA45230AC	GAVAZZI
KA5	RELÄ FASFÖLJD	PHASE SEQUENCE RELAY	DPA01CM44	GAVAZZI
KM1	KONTAKTOR KOMPRESSOR 1	COMPRESSOR 1 CONTACTOR	LS 47 220V	AEG
KM2	KONTAKTOR KOMPRESSOR 2	COMPRESSOR 2 CONTACTOR	LS 47 220V	AEG
KM21	KONTAKT. 1 KONDENSORFLÄKT	FANS CONTACTOR	LS 4 220V	AEG
M1	KOMPRESSOR 1	COMPRESSOR 1	SZ 160	MANEUROP
M2	KOMPRESSOR 2	COMPRESSOR 2	SZ 160	MANEUROP
M21	FLÄKT	FAN	2 X 0,59 kW	
QS	HUVUDSTRÖMBRYTARE	MAIN SWITCH	SIRCO 4X100	SOCOMEK
R1	ELVÄRME KOMPR. 1	CRANKCASE HEATER COMP.1	65 W	MANEUROP
R2	ELVÄRME KOMPR. 1	CRANKCASE HEATER COMP.2	65 W	MANEUROP
RK3	ELVÄRME KONTOLLER	CONTROL ELECTRIC HEATER	120 OHM	
SP.H1	HÖGTRYCKSVAKT 1	HIGH PRESSURE SWITCH 1		
SP.H5	HÖGTRYCKSVAKT 2	HIGH PRESSURE SWITCH 2		
SP.L1	LÅGTRYCKSVAKT 1	LOW PRESSURE SWITCH 1		
SP.L2	LÅGTRYCKSVAKT 2	LOW PRESSURE SWITCH 2		
TC1	TRANSFORMATOR MANÖVER	AUX.TRANSFORMER	300 VA	
TC2	TRANSFORMATOR TERMINAL	TERMINAL TRANSFORMER	TRADR4W024	CAREL
YV.A1	MAGNETVENTIL 1 HÖG TEMP	HIGH TEMP.SOL.VALVE 1	L 30 220V	RANCO
YV.F1	MAGNETVENTIL 1 LÅG TEMP	LOW TEMP.SOL.VALVE 1	HM2 220V	CASTEL
YV.L1	MAGNETVENTIL 1	SOLENOID VALVE 1	HM2 220V	CASTEL
YV.M1	MAGNETVENTIL FÖRÅNGARE 1	EVAP.CONTROL VALVE 1	HM2 220V	CASTEL
YV.S1	MAGNETVENTIL INSPRUTNING 1	INJECTION SOL.VALVE 1	HM2 220V	CASTEL

TILLÄGG AV KOMPONENTER FÖR LE/HP ENHETER - COMPONENTS TO BE ADDED FOR LE/HP UNITS

A10	FRÅN/TILL FLÄKT STYRNING	ON/OFF FAN DRIVER	CONVONOFF0	CAREL
A13	TERMOSTAT BATTERI	BATTERY THERMOSTAT	RTA200B230	CAREL
BT13	GIVARE BATTERI	BATTERY PROBE	NTC	CAREL
E/1	EXTERN MANÖVER SOMMAR/VINTER	SUMMER/WINTER		
KA3	RELÄ VÄRMEPUMP (HP)	HP RELAY	RMIA45230AC	GAVAZZI
KAIE	RELÄ FRÅN/TILL	ON-OFF RELAY	RMIA45230AC	GAVAZZI
KM22	KONTAKTOR FLÄKTAR	FANS CONTACTOR	LS 4 220V	AEG
KM23	KONTAKTOR FLÄKTAR	FANS CONTACTOR	LS 4 220V	AEG
SP.C1	DEFR. TRYCKVAKT 1	DEFR. PRESS.SWITCH 1	016-H6750.B01	RANCO
YV.I1	4-VÄGS VENTIL 1	4 WAY SOLENOID VALVE 1	L 30 220V	RANCO
YV.L5	MAGNETVENTIL 5	SOLENOID VALVE 5	HM2 220V	CASTEL

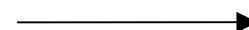

TILLÄGG AV KOMPONENTER FÖR VÄTSKEKYLAGGREGAT CH ENHETER - COMPONENTS TO BE ADDED FOR CH UNITS

Ref.	Beskrivning	Description	Typ/Type	Tillv./Manuf.
BT1	GIVARE INKOMMANDE	INLET USER PROBE	NTC	CAREL
BT2	GIVARE UTGÅENDE	OUTLET USER PROBE	NTC	CAREL
BT3	GIVARE, RETURLUFT	EXTERNAL AIR PROBE	NTC	CAREL
FU40	SÄKRINGAR ELVÄRMEKRETS	HEATER CIRCUIT FUSES	CH10gG 10A	WEBER
KM13	KONTAKTOR PUMP 1	PUMP 1 CONTACTOR	LS 4 220V	AEG
KM14	KONTAKTOR PUMP 2	PUMP 2 CONTACTOR	LS 4 220V	AEG
KM40	KONTAKTOR ELVÄRME FÖRÅNGARE	EVAP.ELECT.HEAT.CONTACTOR	LS 4 220V	AEG
M13	PUMP 1	PUMP 1	1,5 kW	
M14	PUMP 2	PUMP 2	1,5 kW	
QM13	MOTORSKYDD PUMP 1	PUMP MOTOR PROTECTION 1	MBS 25 2,5/4	AEG
QM14	MOTORSKYDD PUMP 2	PUMP MOTOR PROTECTION 2	MBS 25 2,5/4	AEG
R10	ELVÄRME TANK	TANK ELECT.HEATER	300 W	IRCA
R5	ELVÄRME FÖRÅNGARE 1	EVAP.ELECT.HEATER 1	170 W	RICA
R9	ELVÄRME VATTENKRETS	HYDRAULIC CIRC.HEATER	240 W	FER
SP.W	FLÖDESVAKT	FLOW SWITCH		

TILLKOMMANDE KOMPONENTER FÖR VÄRMEPUMPS-UTFÖRANDE (HP)- COMPONENTS TO BE ADDED FOR HP UNITS

A10	PÅ/AV FLÄKT STYRNING	ON/OFF FAN DRIVER	CONVONOFF0	CAREL
A13	TERMOSTAT BATTERI	BATTERY THERMOSTAT	RTA200B230	CAREL
BPH1	TRYCK SIGNALOMV.1	PRESSURE TRANSDUCER 1	SPKT0033R0	CAREL
BT1	GIVARE INKOMMANDE	INLET USER PROBE	NTC	CAREL
BT13	GIVARE BATTERI	BATTERY PROBE	NTC	CAREL
BT2	GIVARE UTGÅENDE	OUTLET USER PROBE	NTC	CAREL
BT3	GIVARE, RETURLUFT	EXTERNAL AIR PROBE	NTC	CAREL
E/1	EXTERN MANÖVER SOMMAR/VINTER	SUMMER/WINTER		
FU40	SÄKRING ELVÄRMEKRETS	HEATER CIRCUIT FUSES	CH10gG 10A	WEBER
KA3	RELÄ VÄRMEPUMP (HP)	HP RELAY	RMIA45230AC	GAVAZZI
KM13	KONTAKTOR PUMP 1	PUMP 1 CONTACTOR	LS 4 220V	AEG
KM14	KONTAKTOR PUMP 2	PUMP 2 CONTACTOR	LS 4 220V	AEG
KM22	KONTAKTOR FLÄKTAR	FANS CONTACTOR	LS 4 220V	AEG
KM23	KONTAKTOR FLÄKTAR	FANS CONTACTOR	LS 4 220V	AEG
KM40	KONTAKTOR ELVÄRME FÖRÅNGARE	EVAP.ELECT.HEAT.CONTACTOR	LS 4 220V	AEG
M13	PUMP 1	PUMP 1	1,5 kW	
M14	PUMP 2	PUMP 2	1,5 kW	
QM13	MOTORSKYDD PUMP 1	PUMP MOTOR PROTECTION 1	MBS 25 2,5/4	AEG
QM14	MOTORSKYDD PUMP 2	PUMP MOTOR PROTECTION 2	MBS 25 2,5/4	AEG
R10	ELVÄRME TANK	TANK ELECT.HEATER	300 W	IRCA
R5	ELVÄRME FÖRÅNGARE 1	EVAP.ELECT.HEATER 1	170 W	RICA
R9	ELVÄRME VATTENKRETS	HYDRAULIC CIRC.HEATER	240 W	FER
SP.C1	DEFR. TRYCKVAKT 1	DEFR. PRESS.SWITCH 1	016-H6750.B01	RANCO
SP.W	FLÖDESVAKT	FLOW SWITCH		
YV.I1	4-VÄGS VENTIL 1	4 WAY SOLENOID VALVE 1	L 30 220V	RANCO
YV.L1	MAGNETVENTIL 1	SOLENOID VALVE 1	HM2 220V	CASTEL

TILLKOMMANDE KOMPONENTER FÖR AGGREGAT MED REDUCERAD PUMP - REDUCED PUMPS

KM13	KONTAKTOR REDUCERAD PUMP 1	REDUCED PUMP 1 CONTACTOR	LS 4 220V	AEG
KM14	KONTAKTOR REDUCERAD PUMP 2	REDUCED PUMP 2 CONTACTOR	LS 4 220V	AEG
M13	REDUCERAD PUMP 1	REDUCED PUMPS 1	1,1 kW	
M14	REDUCERAD PUMP 2	REDUCED PUMPS 2	1,1 kW	
QM13	MOTORSKYDD REDUCERAD PUMP 1	REDUC. PUMP MOTOR PROTEC.1	MBS 25 2,5/4	AEG
QM14	MOTORSKYDD REDUCERAD PUMP 2	REDUC. PUMP MOTOR PROTEC.2	MBS 25 2,5/4	AEG

TILLKOMMANDE KOMPONENTER FÖR AGGREGAT MED ÖVERDIMENSIONERAD PUMP - OVERSIZED PUMPS

KM13	KONTAKTOR ÖVERDIM. PUMP 1	OVERSIZED PUMP 1 CONTACTOR	LS 4 220V	AEG
KM14	KONTAKTOR ÖVERDIM. PUMP 2	OVERSIZED PUMP 2 CONTACTOR	LS 4 220V	AEG
M13	ÖVERDIMENSIONERAD PUMP 1	OVERSIZED PUMPS 1	2,2 kW	
M14	ÖVERDIMENSIONERAD PUMP 2	OVERSIZED PUMPS 2	2,2 kW	
QM13	MOTORSKYDD ÖVERDIM. PUMP 1	OVERSIZED PUMP MOTOR PROTEC.1	MBS 25 4/6,3	AEG
QM14	MOTORSKYDD ÖVERDIM. PUMP 2	OVERSIZED PUMP MOTOR PROTEC.2	MBS 25 4/6,3	AEG

KOMPONENTER FÖR LE- ENHETER

Ref.	Beskrivning	Description	Typ/Type	Tillv./Manuf.
A1	FJÄRR TERMINAL	REMOTE TERMINAL	MCH200TW00	CAREL
A2	KONTROLL KORT 1	CONTROL BOARD 1	CH2000001	CAREL
A3	EXTRA KONTROLL KORT	ADDITIONAL CONTROL BOARD	MCH2000021	CAREL
A38	DUBBLA BÖRVÄRDEN TEMP.	DUAL SET POINTTHERM.	RTA200B230	CAREL
A4	SERIELLT KORT	SERIAL BOARD	MCH2004850	CAREL
A5	STEGLÖS FLÄKTREGLERING	FAN SPEED CONTROL	VRMMS 8	FAE
A6	SERIELLT KORT	SERIAL BOARD	MCH200TSV0	CAREL
BPH1	TRYCK SIGNALOMV.1	PRESSURE TRANSDUCER 1	SPKT0033R0	CAREL
BT38	GIVARE INKOMMANDE	INLET USER PROBE	NTC	CAREL
FT1	Klixon 1	KLICKSON 1		
FT2	Klixon 2	KLICKSON 2		
FU.L	SÄKRING INKOM. MATNING	SUPPLY FUSES		
FU1	SÄKRING KOMPRESSOR 1	COMPRESSOR 1 FUSES	CH14gG 40A	WEBER
FU2	SÄKRING KOMPRESSOR 2	COMPRESSOR 2 FUSES	CH14gG 40A	WEBER
FU50	SÄKRING TRANSFORMATOR TC	AUX.TRANSF.CIRCUIT FUSES	CH10gG 8A	WEBER
FU51	SÄKRING MANÖVERKRETS 230V	AUX. CIRCUIT FUSE	CH10gG 2A	WEBER
FU52	SÄKRING MANÖVERKRETS 24V	CONTROL FUSE	CH10gG 4A	WEBER
FU56	SÄKRING FASFÖLJDSRELÄ	PHASE SEQ.RELAY FUSES	CH10gG 2A	WEBER
IE	EXTERN MANÖVER	EXTERNE INTERLOCK		
IV	FÖRREG.1 KONDENSORFLÄKT.	FANS INTERLOCK		
KA1	SPÄNNINGSRELÄ	VOLTAGE RELAY	RMIA210230AC	GAVAZZI
KA2	RELÄ FLÄKTLARM	FAN ALARM RELAY	RMIA45230AC	GAVAZZI
KA5	RELÄ FASFÖLJD	PHASE SEQUENCE RELAY	DPA01CM44	GAVAZZI
KM1	KONTAKTOR KOMPRESSOR 1	COMPRESSOR 1 CONTACTOR	LS 47 220V	AEG
KM2	KONTAKTOR KOMPRESSOR 2	COMPRESSOR 2 CONTACTOR	LS 47 220V	AEG
KM21	KONTAKT. 1 KONDENSORFLÄKT	FANS CONTACTOR	LS 4 220V	AEG
M1	KOMPRESSOR 1	COMPRESSOR 1	SZ 185	MANEUROP
M2	KOMPRESSOR 2	COMPRESSOR 2	SZ 185	MANEUROP
M21	FLÄKT	FAN	2 X 0,59 kW	
QS	HUVUDSTRÖMBRYTARE	MAIN SWITCH	SIRCO 4X100	SOCOMEK
R1	ELVÄRME KOMPR. 1	CRANKCASE HEATER COMP.1	65 W	MANEUROP
R2	ELVÄRME KOMPR. 1	CRANKCASE HEATER COMP.2	65 W	MANEUROP
RK3	ELVÄRME KONTOLLER	CONTROL ELECTRIC HEATER	120 OHM	
SP.H1	HÖGTRYCKSVAKT 1	HIGH PRESSURE SWITCH 1		
SP.H5	HÖGTRYCKSVAKT 2	HIGH PRESSURE SWITCH 2		
SP.L1	LÅGTRYCKSVAKT 1	LOW PRESSURE SWITCH 1		
SP.L2	LÅGTRYCKSVAKT 2	LOW PRESSURE SWITCH 2		
TC1	TRANSFORMATOR MANÖVER	AUX.TRANSFORMER	300 VA	
TC2	TRANSFORMATOR TERMINAL	TERMINAL TRANSFORMER	TRADR4W024	CAREL
YV.A1	MAGNETVENTIL 1 HÖG TEMP	HIGH TEMP.SOL.VALVE 1	L 30 220V	RANCO
YV.F1	MAGNETVENTIL 1 LÅG TEMP	LOW TEMP.SOL.VALVE 1	HM2 220V	CASTEL
YV.L1	MAGNETVENTIL 1	SOLENOID VALVE 1	HM2 220V	CASTEL
YV.M1	MAGNETVENTIL FÖRÅNGARE 1	EVAP.CONTROL VALVE 1	HM2 220V	CASTEL
YV.S1	MAGNETVENTIL INSPRUTNING 1	INJECTION SOL.VALVE 1	HM2 220V	CASTEL

TILLÄGG AV KOMPONENTER FÖR LE/HP ENHETER - COMPONENTS TO BE ADDED FOR LE/HP UNITS

A10	FRÅN/TILL FLÄKT STYRNING	ON/OFF FAN DRIVER	CONVONOFF0	CAREL
A13	TERMOSTAT BATTERI	BATTERY THERMOSTAT	RTA200B230	CAREL
BT13	GIVARE BATTERI	BATTERY PROBE	NTC	CAREL
E/1	EXTERN MANÖVER SOMMAR/VINTER	SUMMER/WINTER		
KA3	RELÄ VÄRMEPUMP (HP)	HP RELAY	RMIA45230AC	GAVAZZI
KAIE	RELÄ FRÅN/TILL	ON-OFF RELAY	RMIA45230AC	GAVAZZI
KM22	KONTAKTOR FLÄKTAR	FANS CONTACTOR	LS 4 220V	AEG
KM23	KONTAKTOR FLÄKTAR	FANS CONTACTOR	LS 4 220V	AEG
SP.C1	DEFR. TRYCKVAKT 1	DEFR. PRESS.SWITCH 1	016-H6750.B01	RANCO
YV.I1	4-VÄGS VENTIL 1	4 WAY SOLENOID VALVE 1	L 30 220V	RANCO
YV.L5	MAGNETVENTIL 5	SOLENOID VALVE 5	HM2 220V	CASTEL

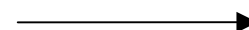

TILLÄGG AV KOMPONENTER FÖR VÄTSKEKYLAGGREGAT CH ENHETER - COMPONENTS TO BE ADDED FOR CH UNITS

Ref.	Beskrivning	Description	Typ/Type	Tillv./Manuf.
BT1	GIVARE INKOMMANDE	INLET USER PROBE	NTC	CAREL
BT2	GIVARE UTGÅENDE	OUTLET USER PROBE	NTC	CAREL
BT3	GIVARE, RETURLUFT	EXTERNAL AIR PROBE	NTC	CAREL
FU40	SÄKRINGAR ELVÄRMEKRETS	HEATER CIRCUIT FUSES	CH10gG 10A	WEBER
KM13	KONTAKTOR PUMP 1	PUMP 1 CONTACTOR	LS 4 220V	AEG
KM14	KONTAKTOR PUMP 2	PUMP 2 CONTACTOR	LS 4 220V	AEG
KM40	KONTAKTOR ELVÄRME FÖRÅNGARE	EVAP.ELECT.HEAT.CONTACTOR	LS 4 220V	AEG
M13	PUMP 1	PUMP 1	1,5 kW	
M14	PUMP 2	PUMP 2	1,5 kW	
QM13	MOTORSKYDD PUMP 1	PUMP MOTOR PROTECTION 1	MBS 25 2,5/4	AEG
QM14	MOTORSKYDD PUMP 2	PUMP MOTOR PROTECTION 2	MBS 25 2,5/4	AEG
R10	ELVÄRME TANK	TANK ELECT.HEATER	300 W	IRCA
R5	ELVÄRME FÖRÅNGARE 1	EVAP.ELECT.HEATER 1	170 W	RICA
R9	ELVÄRME VATTENKRETS	HYDRAULIC CIRC.HEATER	240 W	FER
SP.W	FLÖDESVAKT	FLOW SWITCH		

TILLKOMMANDE KOMPONENTER FÖR VÄRMEPUMPS-UTFÖRANDE (HP)- COMPONENTS TO BE ADDED FOR HP UNITS

A10	PÅ/AV FLÄKT STYRNING	ON/OFF FAN DRIVER	CONVONOFF0	CAREL
A13	TERMOSTAT BATTERI	BATTERY THERMOSTAT	RTA200B230	CAREL
BPH1	TRYCK SIGNALOMV.1	PRESSURE TRANSDUCER 1	SPKT0033R0	CAREL
BT1	GIVARE INKOMMANDE	INLET USER PROBE	NTC	CAREL
BT13	GIVARE BATTERI	BATTERY PROBE	NTC	CAREL
BT2	GIVARE UTGÅENDE	OUTLET USER PROBE	NTC	CAREL
BT3	GIVARE, RETURLUFT	EXTERNAL AIR PROBE	NTC	CAREL
E/1	EXTERN MANÖVER SOMMAR/VINTER	SUMMER/WINTER		
FU40	SÄKRING ELVÄRMEKRETS	HEATER CIRCUIT FUSES	CH10gG 10A	WEBER
KA3	RELÄ VÄRMEPUMP (HP)	HP RELAY	RMIA45230AC	GAVAZZI
KM13	KONTAKTOR PUMP 1	PUMP 1 CONTACTOR	LS 4 220V	AEG
KM14	KONTAKTOR PUMP 2	PUMP 2 CONTACTOR	LS 4 220V	AEG
KM22	KONTAKTOR FLÄKTAR	FANS CONTACTOR	LS 4 220V	AEG
KM23	KONTAKTOR FLÄKTAR	FANS CONTACTOR	LS 4 220V	AEG
KM40	KONTAKTOR ELVÄRME FÖRÅNGARE	EVAP.ELECT.HEAT.CONTACTOR	LS 4 220V	AEG
M13	PUMP 1	PUMP 1	1,5 kW	
M14	PUMP 2	PUMP 2	1,5 kW	
QM13	MOTORSKYDD PUMP 1	PUMP MOTOR PROTECTION 1	MBS 25 2,5/4	AEG
QM14	MOTORSKYDD PUMP 2	PUMP MOTOR PROTECTION 2	MBS 25 2,5/4	AEG
R10	ELVÄRME TANK	TANK ELECT.HEATER	300 W	IRCA
R5	ELVÄRME FÖRÅNGARE 1	EVAP.ELECT.HEATER 1	170 W	RICA
R9	ELVÄRME VATTENKRETS	HYDRAULIC CIRC.HEATER	240 W	FER
SP.C1	DEFR. TRYCKVAKT 1	DEFR. PRESS.SWITCH 1	016-H6750.B01	RANCO
SP.W	FLÖDESVAKT	FLOW SWITCH		
YV.I1	4-VÄGS VENTIL 1	4 WAY SOLENOID VALVE 1	L 30 220V	RANCO
YV.L1	MAGNETVENTIL 1	SOLENOID VALVE 1	HM2 220V	CASTEL

TILLKOMMANDE KOMPONENTER FÖR AGGREGAT MED REDUCERAD PUMP - REDUCED PUMPS

KM13	KONTAKTOR REDUCERAD PUMP 1	REDUCED PUMP 1 CONTACTOR	LS 4 220V	AEG
KM14	KONTAKTOR REDUCERAD PUMP 2	REDUCED PUMP 2 CONTACTOR	LS 4 220V	AEG
M13	REDUCERAD PUMP 1	REDUCED PUMPS 1	1,1 kW	
M14	REDUCERAD PUMP 2	REDUCED PUMPS 2	1,1 kW	
QM13	MOTORSKYDD REDUCERAD PUMP 1	REDUC. PUMP MOTOR PROTEC.1	MBS 25 2,5/4	AEG
QM14	MOTORSKYDD REDUCERAD PUMP 2	REDUC. PUMP MOTOR PROTEC.2	MBS 25 2,5/4	AEG

TILLKOMMANDE KOMPONENTER FÖR AGGREGAT MED ÖVERDIMENSIONERAD PUMP - OVERSIZED PUMPS

KM13	KONTAKTOR ÖVERDIM. PUMP 1	OVERSIZED PUMP 1 CONTACTOR	LS 4 220V	AEG
KM14	KONTAKTOR ÖVERDIM. PUMP 2	OVERSIZED PUMP 2 CONTACTOR	LS 4 220V	AEG
M13	ÖVERDIMENSIONERAD PUMP 1	OVERSIZED PUMPS 1	3,0 kW	
M14	ÖVERDIMENSIONERAD PUMP 2	OVERSIZED PUMPS 2	3,0 kW	
QM13	MOTORSKYDD ÖVERDIM. PUMP 1	OVERSIZED PUMP MOTOR PROTEC.1	MBS 25 6,3/10	AEG
QM14	MOTORSKYDD ÖVERDIM. PUMP 2	OVERSIZED PUMP MOTOR PROTEC.2	MBS 25 6,3/10	AEG

KOMPONENTER FÖR LE- ENHETER

Ref.	Beskrivning	Description	Typ/Type	Tillv./Manuf.
A1	FJÄRR TERMINAL	REMOTE TERMINAL	MCH200TW00	CAREL
A2	KONTROLL KORT 1	CONTROL BOARD 1	CH2000001	CAREL
A3	EXTRA KONTROLL KORT	ADDITIONAL CONTROL BOARD	MCH2000021	CAREL
A38	DUBBLA BÖRVÄRDEN TEMP.	DUAL SET POINTTHERM.	RTA200B230	CAREL
A4	SERIELLT KORT	SERIAL BOARD	MCH2004850	CAREL
A5	STEGLÖS FLÄKTREGLERING	FAN SPEED CONTROL	VRMMS 12	FAE
A6	SERIELLT KORT	SERIAL BOARD	MCH200TSV0	CAREL
BPH1	TRYCK SIGNALOMV.1	PRESSURE TRANSDUCER 1	SPKT0033R0	CAREL
BT38	GIVARE INKOMMANDE	INLET USER PROBE	NTC	CAREL
FT1	Klixon 1	KLICKSON 1		
FT2	Klixon 2	KLICKSON 2		
FU.L	SÄKRING INKOM. MATNING	SUPPLY FUSES		
FU1	SÄKRING KOMPRESSOR 1	COMPRESSOR 1 FUSES	NH00gG 63A	WEBER
FU2	SÄKRING KOMPRESSOR 2	COMPRESSOR 2 FUSES	CH14gG 40A	WEBER
FU50	SÄKRING TRANSFORMATOR TC	AUX.TRANSF.CIRCUIT FUSES	CH10gG 12A	WEBER
FU51	SÄKRING MANÖVERKRETS 230V	AUX. CIRCUIT FUSE	CH10gG 4A	WEBER
FU52	SÄKRING MANÖVERKRETS 24V	CONTROL FUSE	CH10gG 4A	WEBER
FU56	SÄKRING FASFÖLJDSRELÄ	PHASE SEQ.RELAY FUSES	CH10gG 2A	WEBER
IE	EXTERN MANÖVER	EXTERNE INTERLOCK		
IV	FÖRREG.1 KONDENSORFLÄKT.	FANS INTERLOCK		
KA1	SPÄNNINGSRELÄ	VOLTAGE RELAY	RMIA210230AC	GAVAZZI
KA2	RELÄ FLÄKTLARM	FAN ALARM RELAY	RMIA45230AC	GAVAZZI
KA5	RELÄ FASFÖLJD	PHASE SEQUENCE RELAY	DPA01CM44	GAVAZZI
KM1	KONTAKTOR KOMPRESSOR 1	COMPRESSOR 1 CONTACTOR	LS 57 220V	AEG
KM2	KONTAKTOR KOMPRESSOR 2	COMPRESSOR 2 CONTACTOR	LS 47 220V	AEG
KM21	KONTAKT. 1 KONDENSORFLÄKT	FANS CONTACTOR	LS 4 220V	AEG
M1	KOMPRESSOR 1	COMPRESSOR 1	SZ 240	MANEUROP
M2	KOMPRESSOR 2	COMPRESSOR 2	SZ 185	MANEUROP
M21	FLÄKT	FAN	3 X 0,59 kW	
QS	HUVUDSTRÖMBRYTARE	MAIN SWITCH	SIRCO 4X125	SOCOMEK
R1	ELVÄRME KOMPR. 1	CRANKCASE HEATER COMP.1	130 W	MANEUROP
R2	ELVÄRME KOMPR. 1	CRANKCASE HEATER COMP.2	65 W	MANEUROP
RK3	ELVÄRME KONTOLLER	CONTROL ELECTRIC HEATER	120 OHM	
SP.H1	HÖGTRYCKSVAKT 1	HIGH PRESSURE SWITCH 1		
SP.H5	HÖGTRYCKSVAKT 2	HIGH PRESSURE SWITCH 2		
SP.L1	LÅGTRYCKSVAKT 1	LOW PRESSURE SWITCH 1		
SP.L2	LÅGTRYCKSVAKT 2	LOW PRESSURE SWITCH 2		
TC1	TRANSFORMATOR MANÖVER	AUX.TRANSFORMER	600 VA	
TC2	TRANSFORMATOR TERMINAL	TERMINAL TRANSFORMER	TRADR4W024	CAREL
YV.A1	MAGNETVENTIL 1 HÖG TEMP	HIGH TEMP.SOL.VALVE 1	L 30 220V	RANCO
YV.F1	MAGNETVENTIL 1 LÅG TEMP	LOW TEMP.SOL.VALVE 1	HM2 220V	CASTEL
YV.L1	MAGNETVENTIL 1	SOLENOID VALVE 1	HM2 220V	CASTEL
YV.M1	MAGNETVENTIL FÖRÅNGARE 1	EVAP.CONTROL VALVE 1	HM2 220V	CASTEL
YV.S1	MAGNETVENTIL INSPRUTNING 1	INJECTION SOL.VALVE 1	HM2 220V	CASTEL

TILLÄGG AV KOMPONENTER FÖR LE/HP ENHETER - COMPONENTS TO BE ADDED FOR LE/HP UNITS

A10	FRÅN/TILL FLÄKT STYRNING	ON/OFF FAN DRIVER	CONVONOFF0	CAREL
A13	TERMOSTAT BATTERI	BATTERY THERMOSTAT	RTA200B230	CAREL
BT13	GIVARE BATTERI	BATTERY PROBE	NTC	CAREL
E/1	EXTERN MANÖVER SOMMAR/VINTER	SUMMER/WINTER		
KA3	RELÄ VÄRMEPUMP (HP)	HP RELAY	RMIA45230AC	GAVAZZI
KAIE	RELÄ FRÅN/TILL	ON-OFF RELAY	RMIA45230AC	GAVAZZI
KM22	KONTAKTOR FLÄKTAR	FANS CONTACTOR	LS 4 220V	AEG
KM23	KONTAKTOR FLÄKTAR	FANS CONTACTOR	LS 4 220V	AEG
SP.C1	DEFR. TRYCKVAKT 1	DEFR. PRESS.SWITCH 1	016-H6750.B01	RANCO
YV.I1	4-VÄGS VENTIL 1	4 WAY SOLENOID VALVE 1	L 30 220V	RANCO
YV.L5	MAGNETVENTIL 5	SOLENOID VALVE 5	HM2 220V	CASTEL

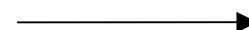

TILLÄGG AV KOMPONENTER FÖR VÄTSKEKYLAGGREGAT CH ENHETER - COMPONENTS TO BE ADDED FOR CH UNITS

Ref.	Beskrivning	Description	Typ/Type	Tillv./Manuf.
BT1	GIVARE INKOMMANDE	INLET USER PROBE	NTC	CAREL
BT2	GIVARE UTGÅENDE	OUTLET USER PROBE	NTC	CAREL
BT3	GIVARE, RETURLUFT	EXTERNAL AIR PROBE	NTC	CAREL
FU40	SÄKRINGAR ELVÄRMEKRETS	HEATER CIRCUIT FUSES	CH10gG 10A	WEBER
KM13	KONTAKTOR PUMP 1	PUMP 1 CONTACTOR	LS 4 220V	AEG
KM14	KONTAKTOR PUMP 2	PUMP 2 CONTACTOR	LS 4 220V	AEG
KM40	KONTAKTOR ELVÄRME FÖRÅNGARE	EVAP.ELECT.HEAT.CONTACTOR	LS 4 220V	AEG
M13	PUMP 1	PUMP 1	1,5 kW	
M14	PUMP 2	PUMP 2	1,5 kW	
QM13	MOTORSKYDD PUMP 1	PUMP MOTOR PROTECTION 1	MBS 25 2,5/4	AEG
QM14	MOTORSKYDD PUMP 2	PUMP MOTOR PROTECTION 2	MBS 25 2,5/4	AEG
R10	ELVÄRME TANK	TANK ELECT.HEATER	300 W	IRCA
R5	ELVÄRME FÖRÅNGARE 1	EVAP.ELECT.HEATER 1	170 W	RICA
R9	ELVÄRME VATTENKRETS	HYDRAULIC CIRC.HEATER	240 W	FER
SP.W	FLÖDESVAKT	FLOW SWITCH		

TILLKOMMANDE KOMPONENTER FÖR VÄRMEPUMPS-UTFÖRANDE (HP)- COMPONENTS TO BE ADDED FOR HP UNITS

A10	PÅ/AV FLÄKT STYRNING	ON/OFF FAN DRIVER	CONVONOFF0	CAREL
A13	TERMOSTAT BATTERI	BATTERY THERMOSTAT	RTA200B230	CAREL
BPH1	TRYCK SIGNALOMV.1	PRESSURE TRANSDUCER 1	SPKT0033R0	CAREL
BT1	GIVARE INKOMMANDE	INLET USER PROBE	NTC	CAREL
BT13	GIVARE BATTERI	BATTERY PROBE	NTC	CAREL
BT2	GIVARE UTGÅENDE	OUTLET USER PROBE	NTC	CAREL
BT3	GIVARE, RETURLUFT	EXTERNAL AIR PROBE	NTC	CAREL
E/1	EXTERN MANÖVER SOMMAR/VINTER	SUMMER/WINTER		
FU40	SÄKRING ELVÄRMEKRETS	HEATER CIRCUIT FUSES	CH10gG 10A	WEBER
KA3	RELÄ VÄRMEPUMP (HP)	HP RELAY	RMIA45230AC	GAVAZZI
KM13	KONTAKTOR PUMP 1	PUMP 1 CONTACTOR	LS 4 220V	AEG
KM14	KONTAKTOR PUMP 2	PUMP 2 CONTACTOR	LS 4 220V	AEG
KM22	KONTAKTOR FLÄKTAR	FANS CONTACTOR	LS 4 220V	AEG
KM23	KONTAKTOR FLÄKTAR	FANS CONTACTOR	LS 4 220V	AEG
KM40	KONTAKTOR ELVÄRME FÖRÅNGARE	EVAP.ELECT.HEAT.CONTACTOR	LS 4 220V	AEG
M13	PUMP 1	PUMP 1	1,5 kW	
M14	PUMP 2	PUMP 2	1,5 kW	
QM13	MOTORSKYDD PUMP 1	PUMP MOTOR PROTECTION 1	MBS 25 2,5/4	AEG
QM14	MOTORSKYDD PUMP 2	PUMP MOTOR PROTECTION 2	MBS 25 2,5/4	AEG
R10	ELVÄRME TANK	TANK ELECT.HEATER	300 W	IRCA
R5	ELVÄRME FÖRÅNGARE 1	EVAP.ELECT.HEATER 1	170 W	RICA
R9	ELVÄRME VATTENKRETS	HYDRAULIC CIRC.HEATER	240 W	FER
SP.C1	DEFR. TRYCKVAKT 1	DEFR. PRESS.SWITCH 1	016-H6750.B01	RANCO
SP.W	FLÖDESVAKT	FLOW SWITCH		
YV.I1	4-VÄGS VENTIL 1	4 WAY SOLENOID VALVE 1	L 30 220V	RANCO
YV.L1	MAGNETVENTIL 1	SOLENOID VALVE 1	HM2 220V	CASTEL

TILLKOMMANDE KOMPONENTER FÖR AGGREGAT MED REDUCERAD PUMP - REDUCED PUMPS

KM13	KONTAKTOR REDUCERAD PUMP 1	REDUCED PUMP 1 CONTACTOR	LS 4 220V	AEG
KM14	KONTAKTOR REDUCERAD PUMP 2	REDUCED PUMP 2 CONTACTOR	LS 4 220V	AEG
M13	REDUCERAD PUMP 1	REDUCED PUMPS 1	1,1 kW	
M14	REDUCERAD PUMP 2	REDUCED PUMPS 2	1,1 kW	
QM13	MOTORSKYDD REDUCERAD PUMP 1	REDUC. PUMP MOTOR PROTEC.1	MBS 25 2,5/4	AEG
QM14	MOTORSKYDD REDUCERAD PUMP 2	REDUC. PUMP MOTOR PROTEC.2	MBS 25 2,5/4	AEG

TILLKOMMANDE KOMPONENTER FÖR AGGREGAT MED ÖVERDIMENSIONERAD PUMP - OVERSIZED PUMPS

KM13	KONTAKTOR ÖVERDIM. PUMP 1	OVERSIZED PUMP 1 CONTACTOR	LS 4 220V	AEG
KM14	KONTAKTOR ÖVERDIM. PUMP 2	OVERSIZED PUMP 2 CONTACTOR	LS 4 220V	AEG
M13	ÖVERDIMENSIONERAD PUMP 1	OVERSIZED PUMPS 1	3,0 kW	
M14	ÖVERDIMENSIONERAD PUMP 2	OVERSIZED PUMPS 2	3,0 kW	
QM13	MOTORSKYDD ÖVERDIM. PUMP 1	OVERSIZED PUMP MOTOR PROTEC.1	MBS 25 6,3/10	AEG
QM14	MOTORSKYDD ÖVERDIM. PUMP 2	OVERSIZED PUMP MOTOR PROTEC.2	MBS 25 6,3/10	AEG

KOMPONENTER FÖR LE- ENHETER

Ref.	Beskrivning	Description	Typ/Type	Tillv./Manuf.
A1	FJÄRR TERMINAL	REMOTE TERMINAL	MCH200TW00	CAREL
A2	KONTROLL KORT 1	CONTROL BOARD 1	CH2000001	CAREL
A3	EXTRA KONTROLL KORT	ADDITIONAL CONTROL BOARD	MCH2000021	CAREL
A38	DUBBLA BÖRVÅRDEN TEMP.	DUAL SET POINTTHERM.	RTA200B230	CAREL
A4	SERIELLT KORT	SERIAL BOARD	MCH2004850	CAREL
A5	STEGLÖS FLÄKTREGLERING	FAN SPEED CONTROL	VRMMS 12	FAE
A6	SERIELLT KORT	SERIAL BOARD	MCH200TSV0	CAREL
BPH1	TRYCK SIGNALOMV.1	PRESSURE TRANSDUCER 1	SPKT0033R0	CAREL
BT38	GIVARE INKOMMANDE	INLET USER PROBE	NTC	CAREL
FT1	Klixon 1	KLICKSON 1		
FT2	Klixon 2	KLICKSON 2		
FU.L	SÄKRING INKOM. MATNING	SUPPLY FUSES		
FU1	SÄKRING KOMPRESSOR 1	COMPRESSOR 1 FUSES	NH00gG 63A	WEBER
FU2	SÄKRING KOMPRESSOR 2	COMPRESSOR 2 FUSES	NH00gG 63A	WEBER
FU50	SÄKRING TRANSFORMATOR TC	AUX.TRANSF.CIRCUIT FUSES	CH10gG 12A	WEBER
FU51	SÄKRING MANÖVERKRETS 230V	AUX. CIRCUIT FUSE	CH10gG 4A	WEBER
FU52	SÄKRING MANÖVERKRETS 24V	CONTROL FUSE	CH10gG 4A	WEBER
FU56	SÄKRING FASFÖLJDSRELÄ	PHASE SEQ.RELAY FUSES	CH10gG 2A	WEBER
IE	EXTERN MANÖVER	EXTERNE INTERLOCK		
IV	FÖRREG.1 KONDENSORFLÄKT.	FANS INTERLOCK		
KA1	SPÄNNINGSRELÄ	VOLTAGE RELAY	RMIA210230AC	GAVAZZI
KA2	RELÄ FLÄKTLARM	FAN ALARM RELAY	RMIA45230AC	GAVAZZI
KA5	RELÄ FASFÖLJD	PHASE SEQUENCE RELAY	DPA01CM44	GAVAZZI
KM1	KONTAKTOR KOMPRESSOR 1	COMPRESSOR 1 CONTACTOR	LS 57 220V	AEG
KM2	KONTAKTOR KOMPRESSOR 2	COMPRESSOR 2 CONTACTOR	LS 57 220V	AEG
KM21	KONTAKT. 1 KONDENSORFLÄKT	FANS CONTACTOR	LS 4 220V	AEG
M1	KOMPRESSOR 1	COMPRESSOR 1	SZ 240	MANEUROP
M2	KOMPRESSOR 2	COMPRESSOR 2	SZ 240	MANEUROP
M21	FLÄKT	FAN	3 X 0,59 kW	
QS	HUVUDSTRÖMBRYTARE	MAIN SWITCH	SIRCO 4X160	SOCOMEK
R1	ELVÄRME KOMPR. 1	CRANKCASE HEATER COMP.1	130 W	MANEUROP
R2	ELVÄRME KOMPR. 1	CRANKCASE HEATER COMP.2	130 W	MANEUROP
RK3	ELVÄRME KONTOLLER	CONTROL ELECTRIC HEATER	120 OHM	
SP.H1	HÖGTRYCKSVAKT 1	HIGH PRESSURE SWITCH 1		
SP.H5	HÖGTRYCKSVAKT 2	HIGH PRESSURE SWITCH 2		
SP.L1	LÅGTRYCKSVAKT 1	LOW PRESSURE SWITCH 1		
SP.L2	LÅGTRYCKSVAKT 2	LOW PRESSURE SWITCH 2		
TC1	TRANSFORMATOR MANÖVER	AUX.TRANSFORMER	600 VA	
TC2	TRANSFORMATOR TERMINAL	TERMINAL TRANSFORMER	TRADR4W024	CAREL
YV.A1	MAGNETVENTIL 1 HÖG TEMP	HIGH TEMP.SOL.VALVE 1	L 30 220V	RANCO
YV.F1	MAGNETVENTIL 1 LÅG TEMP	LOW TEMP.SOL.VALVE 1	HM2 220V	CASTEL
YV.L1	MAGNETVENTIL 1	SOLENOID VALVE 1	HM2 220V	CASTEL
YV.M1	MAGNETVENTIL FÖRÅNGARE 1	EVAP.CONTROL VALVE 1	HM2 220V	CASTEL
YV.S1	MAGNETVENTIL INSPRUTNING 1	INJECTION SOL.VALVE 1	HM2 220V	CASTEL

TILLÄGG AV KOMPONENTER FÖR LE/HP ENHETER - COMPONENTS TO BE ADDED FOR LE/HP UNITS

A10	FRÅN/TILL FLÄKT STYRNING	ON/OFF FAN DRIVER	CONVONOFF0	CAREL
A13	TERMOSTAT BATTERI	BATTERY THERMOSTAT	RTA200B230	CAREL
BT13	GIVARE BATTERI	BATTERY PROBE	NTC	CAREL
E/1	EXTERN MANÖVER SOMMAR/VINTER	SUMMER/WINTER		
KA3	RELÄ VÄRMEPUMP (HP)	HP RELAY	RMIA45230AC	GAVAZZI
KAIE	RELÄ FRÅN/TILL	ON-OFF RELAY	RMIA45230AC	GAVAZZI
KM22	KONTAKTOR FLÄKTAR	FANS CONTACTOR	LS 4 220V	AEG
KM23	KONTAKTOR FLÄKTAR	FANS CONTACTOR	LS 4 220V	AEG
SP.C1	DEFR. TRYCKVAKT 1	DEFR. PRESS.SWITCH 1	016-H6750.B01	RANCO
YV.I1	4-VÄGS VENTIL 1	4 WAY SOLENOID VALVE 1	L 30 220V	RANCO
YV.L5	MAGNETVENTIL 5	SOLENOID VALVE 5	HM2 220V	CASTEL



TILLÄGG AV KOMPONENTER FÖR VÄTSKEKYLAGGREGAT CH ENHETER - COMPONENTS TO BE ADDED FOR CH UNITS

Ref.	Beskrivning	Description	Typ/Type	Tillv./Manuf.
BT1	GIVARE INKOMMANDE	INLET USER PROBE	NTC	CAREL
BT2	GIVARE UTGÅENDE	OUTLET USER PROBE	NTC	CAREL
BT3	GIVARE, RETURLUFT	EXTERNAL AIR PROBE	NTC	CAREL
FU40	SÄKRINGAR ELVÄRMEKRETS	HEATER CIRCUIT FUSES	CH10gG 10A	WEBER
KM13	KONTAKTOR PUMP 1	PUMP 1 CONTACTOR	LS 4 220V	AEG
KM14	KONTAKTOR PUMP 2	PUMP 2 CONTACTOR	LS 4 220V	AEG
KM40	KONTAKTOR ELVÄRME FÖRÅNGARE	EVAP.ELECT.HEAT.CONTACTOR	LS 4 220V	AEG
M13	PUMP 1	PUMP 1	1,5 kW	
M14	PUMP 2	PUMP 2	1,5 kW	
QM13	MOTORSKYDD PUMP 1	PUMP MOTOR PROTECTION 1	MBS 25 2,5/4	AEG
QM14	MOTORSKYDD PUMP 2	PUMP MOTOR PROTECTION 2	MBS 25 2,5/4	AEG
R10	ELVÄRME TANK	TANK ELECT.HEATER	300 W	IRCA
R5	ELVÄRME FÖRÅNGARE 1	EVAP.ELECT.HEATER 1	170 W	RICA
R9	ELVÄRME VATTENKRETS	HYDRAULIC CIRC.HEATER	240W	FER
SP.W	FLÖDESVAKT	FLOW SWITCH		

TILLKOMMANDE KOMPONENTER FÖR VÄRMEPUMPS-UTFÖRANDE (HP)- COMPONENTS TO BE ADDED FOR HP UNITS

A10	PÅ/AV FLÄKT STYRNING	ON/OFF FAN DRIVER	CONVONOFF0	CAREL
A13	TERMOSTAT BATTERI	BATTERY THERMOSTAT	RTA200B230	CAREL
BPH1	TRYCK SIGNALOMV.1	PRESSURE TRANSDUCER 1	SPKT0033R0	CAREL
BT1	GIVARE INKOMMANDE	INLET USER PROBE	NTC	CAREL
BT13	GIVARE BATTERI	BATTERY PROBE	NTC	CAREL
BT2	GIVARE UTGÅENDE	OUTLET USER PROBE	NTC	CAREL
BT3	GIVARE, RETURLUFT	EXTERNAL AIR PROBE	NTC	CAREL
E/1	EXTERN MANÖVER SOMMAR/VINTER	SUMMER/WINTER		
FU40	SÄKRING ELVÄRMEKRETS	HEATER CIRCUIT FUSES	CH10gG 10A	WEBER
KA3	RELÄ VÄRMEPUMP (HP)	HP RELAY	RMIA45230AC	GAVAZZI
KM13	KONTAKTOR PUMP 1	PUMP 1 CONTACTOR	LS 4 220V	AEG
KM14	KONTAKTOR PUMP 2	PUMP 2 CONTACTOR	LS 4 220V	AEG
KM22	KONTAKTOR FLÄKTAR	FANS CONTACTOR	LS 4 220V	AEG
KM23	KONTAKTOR FLÄKTAR	FANS CONTACTOR	LS 4 220V	AEG
KM40	KONTAKTOR ELVÄRME FÖRÅNGARE	EVAP.ELECT.HEAT.CONTACTOR	LS 4 220V	AEG
M13	PUMP 1	PUMP 1	1,5 kW	
M14	PUMP 2	PUMP 2	1,5 kW	
QM13	MOTORSKYDD PUMP 1	PUMP MOTOR PROTECTION 1	MBS 25 2,5/4	AEG
QM14	MOTORSKYDD PUMP 2	PUMP MOTOR PROTECTION 2	MBS 25 2,5/4	AEG
R10	ELVÄRME TANK	TANK ELECT.HEATER	300 W	IRCA
R5	ELVÄRME FÖRÅNGARE 1	EVAP.ELECT.HEATER 1	170 W	RICA
R9	ELVÄRME VATTENKRETS	HYDRAULIC CIRC.HEATER	240 W	FER
SP.C1	DEFR. TRYCKVAKT 1	DEFR. PRESS.SWITCH 1	016-H6750.B01	RANCO
SP.W	FLÖDESVAKT	FLOW SWITCH		
YV.I1	4-VÄGS VENTIL 1	4 WAY SOLENOID VALVE 1	L 30 220V	RANCO
YV.L1	MAGNETVENTIL 1	SOLENOID VALVE 1	HM2 220V	CASTEL

TILLKOMMANDE KOMPONENTER FÖR AGGREGAT MED REDUCERAD PUMP - REDUCED PUMPS

KM13	KONTAKTOR REDUCERAD PUMP 1	REDUCED PUMP 1 CONTACTOR	LS 4 220V	AEG
KM14	KONTAKTOR REDUCERAD PUMP 2	REDUCED PUMP 2 CONTACTOR	LS 4 220V	AEG
M13	REDUCERAD PUMP 1	REDUCED PUMPS 1	1,1 kW	
M14	REDUCERAD PUMP 2	REDUCED PUMPS 2	1,1 kW	
QM13	MOTORSKYDD REDUCERAD PUMP 1	REDUC. PUMP MOTOR PROTEC.1	MBS 25 2,5/4	AEG
QM14	MOTORSKYDD REDUCERAD PUMP 2	REDUC. PUMP MOTOR PROTEC.2	MBS 25 2,5/4	AEG

TILLKOMMANDE KOMPONENTER FÖR AGGREGAT MED ÖVERDIMENSIONERAD PUMP - OVERSIZED PUMPS

KM13	KONTAKTOR ÖVERDIM. PUMP 1	OVERSIZED PUMP 1 CONTACTOR	LS 4 220V	AEG
KM14	KONTAKTOR ÖVERDIM. PUMP 2	OVERSIZED PUMP 2 CONTACTOR	LS 4 220V	AEG
M13	ÖVERDIMENSIONERAD PUMP 1	OVERSIZED PUMPS 1	3,0 kW	
M14	ÖVERDIMENSIONERAD PUMP 2	OVERSIZED PUMPS 2	3,0 kW	
QM13	MOTORSKYDD ÖVERDIM. PUMP 1	OVERSIZED PUMP MOTOR PROTEC.1	MBS 25 6,3/10	AEG
QM14	MOTORSKYDD ÖVERDIM. PUMP 2	OVERSIZED PUMP MOTOR PROTEC.2	MBS 25 6,3/10	AEG

KOMPONENTER FÖR LE- ENHETER

Ref.	Beskrivning	Description	Typ/Type	Tillv./Manuf.
A1	FJÄRR TERMINAL	REMOTE TERMINAL	MCH200TW00	CAREL
A2	KONTROLL KORT 1	CONTROL BOARD 1	CH2000001	CAREL
A3	EXTRA KONTROLL KORT	ADDITIONAL CONTROL BOARD	MCH2000021	CAREL
A38	DUBBLA BÖRVÄRDEN TEMP.	DUAL SET POINTTHERM.	RTA200B230	CAREL
A4	SERIELLT KORT	SERIAL BOARD	MCH2004850	CAREL
A5	STEGLÖS FLÄKTREGLERING	FAN SPEED CONTROL	VRMMS 12	FAE
A6	SERIELLT KORT	SERIAL BOARD	MCH200TSV0	CAREL
BPH1	TRYCK SIGNALOMV.1	PRESSURE TRANSDUCER 1	SPKT0033R0	CAREL
BT38	GIVARE INKOMMANDE	INLET USER PROBE	NTC	CAREL
FT1	Klixon 1	KLICKSON 1		
FT2	Klixon 2	KLICKSON 2		
FU.L	SÄKRING INKOM. MATNING	SUPPLY FUSES		
FU1	SÄKRING KOMPRESSOR 1	COMPRESSOR 1 FUSES	NH00gG 80A	WEBER
FU2	SÄKRING KOMPRESSOR 2	COMPRESSOR 2 FUSES	NH00gG 63A	WEBER
FU50	SÄKRING TRANSFORMATOR TC	AUX.TRANSF.CIRCUIT FUSES	CH10gG 12A	WEBER
FU51	SÄKRING MANÖVERKRETS 230V	AUX. CIRCUIT FUSE	CH10gG 4A	WEBER
FU52	SÄKRING MANÖVERKRETS 24V	CONTROL FUSE	CH10gG 4A	WEBER
FU56	SÄKRING FASFÖLJDSRELÄ	PHASE SEQ.RELAY FUSES	CH10gG 2A	WEBER
IE	EXTERN MANÖVER	EXTERNE INTERLOCK		
IV	FÖRREG.1 KONDENSORFLÄKT.	FANS INTERLOCK		
KA1	SPÄNNINGSRELÄ	VOLTAGE RELAY	RMIA210230AC	GAVAZZI
KA2	RELÄ FLÄKTLARM	FAN ALARM RELAY	RMIA45230AC	GAVAZZI
KA5	RELÄ FASFÖLJD	PHASE SEQUENCE RELAY	DPA01CM44	GAVAZZI
KM1	KONTAKTOR KOMPRESSOR 1	COMPRESSOR 1 CONTACTOR	LS 77 220V	AEG
KM2	KONTAKTOR KOMPRESSOR 2	COMPRESSOR 2 CONTACTOR	LS 77 220V	AEG
KM21	KONTAKT. 1 KONDENSORFLÄKT	FANS CONTACTOR	LS 4 220V	AEG
M1	KOMPRESSOR 1	COMPRESSOR 1	SZ 300	MANEUROP
M2	KOMPRESSOR 2	COMPRESSOR 2	SZ 240	MANEUROP
M21	FLÄKT	FAN	3 X 0,59 kW	
QS	HUVUDSTRÖMBRYTARE	MAIN SWITCH	SIRCO 4X200	SOCOMEK
R1	ELVÄRME KOMPR. 1	CRANKCASE HEATER COMP.1	130 W	MANEUROP
R2	ELVÄRME KOMPR. 1	CRANKCASE HEATER COMP.2	130 W	MANEUROP
RK3	ELVÄRME KONTOLLER	CONTROL ELECTRIC HEATER	120 OHM	
SP.H1	HÖGTRYCKSVAKT 1	HIGH PRESSURE SWITCH 1		
SP.H5	HÖGTRYCKSVAKT 2	HIGH PRESSURE SWITCH 2		
SP.L1	LÅGTRYCKSVAKT 1	LOW PRESSURE SWITCH 1		
SP.L2	LÅGTRYCKSVAKT 2	LOW PRESSURE SWITCH 2		
TC1	TRANSFORMATOR MANÖVER	AUX.TRANSFORMER	600 VA	
TC2	TRANSFORMATOR TERMINAL	TERMINAL TRANSFORMER	TRADR4W024	CAREL
YV.A1	MAGNETVENTIL 1 HÖG TEMP	HIGH TEMP.SOL.VALVE 1	L 30 220V	RANCO
YV.F1	MAGNETVENTIL 1 LÅG TEMP	LOW TEMP.SOL.VALVE 1	HM2 220V	CASTEL
YV.L1	MAGNETVENTIL 1	SOLENOID VALVE 1	HM2 220V	CASTEL
YV.M1	MAGNETVENTIL FÖRÅNGARE 1	EVAP.CONTROL VALVE 1	HM2 220V	CASTEL
YV.S1	MAGNETVENTIL INSPRUTNING 1	INJECTION SOL.VALVE 1	HM2 220V	CASTEL

TILLÄGG AV KOMPONENTER FÖR LE/HP ENHETER - COMPONENTS TO BE ADDED FOR LE/HP UNITS

A10	FRÅN/TILL FLÄKT STYRNING	ON/OFF FAN DRIVER	CONVONOFF0	CAREL
A13	TERMOSTAT BATTERI	BATTERY THERMOSTAT	RTA200B230	CAREL
BT13	GIVARE BATTERI	BATTERY PROBE	NTC	CAREL
E/1	EXTERN MANÖVER SOMMAR/VINTER	SUMMER/WINTER		
KA3	RELÄ VÄRMEPUMP (HP)	HP RELAY	RMIA45230AC	GAVAZZI
KAIE	RELÄ FRÅN/TILL	ON-OFF RELAY	RMIA45230AC	GAVAZZI
KM22	KONTAKTOR FLÄKTAR	FANS CONTACTOR	LS 4 220V	AEG
KM23	KONTAKTOR FLÄKTAR	FANS CONTACTOR	LS 4 220V	AEG
SP.C1	DEFR. TRYCKVAKT 1	DEFR. PRESS.SWITCH 1	016-H6750.B01	RANCO
YV.I1	4-VÄGS VENTIL 1	4 WAY SOLENOID VALVE 1	L 30 220V	RANCO
YV.L5	MAGNETVENTIL 5	SOLENOID VALVE 5	HM2 220V	CASTEL

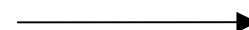

TILLÄGG AV KOMPONENTER FÖR VÄTSKEKYLAGGREGAT CH ENHETER - COMPONENTS TO BE ADDED FOR CH UNITS

Ref.	Beskrivning	Description	Typ/Type	Tillv./Manuf.
BT1	GIVARE INKOMMANDE	INLET USER PROBE	NTC	CAREL
BT2	GIVARE UTGÅENDE	OUTLET USER PROBE	NTC	CAREL
BT3	GIVARE, RETURLUFT	EXTERNAL AIR PROBE	NTC	CAREL
FU40	SÄKRINGAR ELVÄRMEKRETS	HEATER CIRCUIT FUSES	CH10gG 10A	WEBER
KM13	KONTAKTOR PUMP 1	PUMP 1 CONTACTOR	LS 4 220V	AEG
KM14	KONTAKTOR PUMP 2	PUMP 2 CONTACTOR	LS 4 220V	AEG
KM40	KONTAKTOR ELVÄRME FÖRÅNGARE	EVAP.ELECT.HEAT.CONTACTOR	LS 4 220V	AEG
M13	PUMP 1	PUMP 1	2,2 kW	
M14	PUMP 2	PUMP 2	2,2 kW	
QM13	MOTORSKYDD PUMP 1	PUMP MOTOR PROTECTION 1	MBS 25 4/6,3	AEG
QM14	MOTORSKYDD PUMP 2	PUMP MOTOR PROTECTION 2	MBS 25 4/6,3	AEG
R10	ELVÄRME TANK	TANK ELECT.HEATER	300 W	IRCA
R5	ELVÄRME FÖRÅNGARE 1	EVAP.ELECT.HEATER 1	170 W	RICA
R9	ELVÄRME VATTENKRETS	HYDRAULIC CIRC.HEATER	240W	FER
SP.W	FLÖDESVAKT	FLOW SWITCH		

TILLKOMMANDE KOMPONENTER FÖR VÄRMEPUMPS-UTFÖRANDE (HP)- COMPONENTS TO BE ADDED FOR HP UNITS

A10	PÅ/AV FLÄKT STYRNING	ON/OFF FAN DRIVER	CONVONOFF0	CAREL
A13	TERMOSTAT BATTERI	BATTERY THERMOSTAT	RTA200B230	CAREL
BPH1	TRYCK SIGNALOMV.1	PRESSURE TRANSDUCER 1	SPKT0033R0	CAREL
BT1	GIVARE INKOMMANDE	INLET USER PROBE	NTC	CAREL
BT13	GIVARE BATTERI	BATTERY PROBE	NTC	CAREL
BT2	GIVARE UTGÅENDE	OUTLET USER PROBE	NTC	CAREL
BT3	GIVARE, RETURLUFT	EXTERNAL AIR PROBE	NTC	CAREL
E/1	EXTERN MANÖVER SOMMAR/VINTER	SUMMER/WINTER		
FU40	SÄKRING ELVÄRMEKRETS	HEATER CIRCUIT FUSES	CH10gG 10A	WEBER
KA3	RELÄ VÄRMEPUMP (HP)	HP RELAY	RMIA45230AC	GAVAZZI
KM13	KONTAKTOR PUMP 1	PUMP 1 CONTACTOR	LS 4 220V	AEG
KM14	KONTAKTOR PUMP 2	PUMP 2 CONTACTOR	LS 4 220V	AEG
KM22	KONTAKTOR FLÄKTAR	FANS CONTACTOR	LS 4 220V	AEG
KM23	KONTAKTOR FLÄKTAR	FANS CONTACTOR	LS 4 220V	AEG
KM40	KONTAKTOR ELVÄRME FÖRÅNGARE	EVAP.ELECT.HEAT.CONTACTOR	LS 4 220V	AEG
M13	PUMP 1	PUMP 1	2,2 kW	
M14	PUMP 2	PUMP 2	2,2 kW	
QM13	MOTORSKYDD PUMP 1	PUMP MOTOR PROTECTION 1	MBS 25 4/6,3	AEG
QM14	MOTORSKYDD PUMP 2	PUMP MOTOR PROTECTION 2	MBS 25 4/6,3	AEG
R10	ELVÄRME TANK	TANK ELECT.HEATER	300 W	IRCA
R5	ELVÄRME FÖRÅNGARE 1	EVAP.ELECT.HEATER 1	170 W	RICA
R9	ELVÄRME VATTENKRETS	HYDRAULIC CIRC.HEATER	240 W	FER
SP.C1	DEFR. TRYCKVAKT 1	DEFR. PRESS.SWITCH 1	016-H6750.B01	RANCO
SP.W	FLÖDESVAKT	FLOW SWITCH		
YV.I1	4-VÄGS VENTIL 1	4 WAY SOLENOID VALVE 1	L 30 220V	RANCO
YV.L1	MAGNETVENTIL 1	SOLENOID VALVE 1	HM2 220V	CASTEL

TILLKOMMANDE KOMPONENTER FÖR AGGREGAT MED REDUCERAD PUMP - REDUCED PUMPS

KM13	KONTAKTOR REDUCERAD PUMP 1	REDUCED PUMP 1 CONTACTOR	LS 4 220V	AEG
KM14	KONTAKTOR REDUCERAD PUMP 2	REDUCED PUMP 2 CONTACTOR	LS 4 220V	AEG
M13	REDUCERAD PUMP 1	REDUCED PUMPS 1	1,5 kW	
M14	REDUCERAD PUMP 2	REDUCED PUMPS 2	1,5 kW	
QM13	MOTORSKYDD REDUCERAD PUMP 1	REDUC. PUMP MOTOR PROTEC.1	MBS 25 2,5/4	AEG
QM14	MOTORSKYDD REDUCERAD PUMP 2	REDUC. PUMP MOTOR PROTEC.2	MBS 25 2,5/4	AEG

TILLKOMMANDE KOMPONENTER FÖR AGGREGAT MED ÖVERDIMENSIONERAD PUMP - OVERSIZED PUMPS

KM13	KONTAKTOR ÖVERDIM. PUMP 1	OVERSIZED PUMP 1 CONTACTOR	LS 7 220V	AEG
KM14	KONTAKTOR ÖVERDIM. PUMP 2	OVERSIZED PUMP 2 CONTACTOR	LS 7 220V	AEG
M13	ÖVERDIMENSIONERAD PUMP 1	OVERSIZED PUMPS 1	4,0 kW	
M14	ÖVERDIMENSIONERAD PUMP 2	OVERSIZED PUMPS 2	4,0 kW	
QM13	MOTORSKYDD ÖVERDIM. PUMP 1	OVERSIZED PUMP MOTOR PROTEC.1	MBS 25 6,3/10	AEG
QM14	MOTORSKYDD ÖVERDIM. PUMP 2	OVERSIZED PUMP MOTOR PROTEC.2	MBS 25 6,3/10	AEG

KOMPONENTER FÖR LE- ENHETER

Ref.	Beskrivning	Description	Typ/Type	Tillv./Manuf.
A1	FJÄRR TERMINAL	REMOTE TERMINAL	MCH200TW00	CAREL
A2	KONTROLL KORT 1	CONTROL BOARD 1	CH2000001	CAREL
A3	EXTRA KONTROLL KORT	ADDITIONAL CONTROL BOARD	MCH2000021	CAREL
A38	DUBBLA BÖRVÅRDEN TEMP.	DUAL SET POINTTHERM.	RTA200B230	CAREL
A4	SERIELLT KORT	SERIAL BOARD	MCH2004850	CAREL
A5	STEGLÖS FLÄKTREGLERING	FAN SPEED CONTROL	VRMMS 12	FAE
A6	SERIELLT KORT	SERIAL BOARD	MCH200TSV0	CAREL
BPH1	TRYCK SIGNALOMV.1	PRESSURE TRANSDUCER 1	SPKT0033R0	CAREL
BT38	GIVARE INKOMMANDE	INLET USER PROBE	NTC	CAREL
FT1	Klixon 1	KLICKSON 1		
FT2	Klixon 2	KLICKSON 2		
FU.L	SÄKRING INKOM. MATNING	SUPPLY FUSES		
FU1	SÄKRING KOMPRESSOR 1	COMPRESSOR 1 FUSES	NH00gG 80A	WEBER
FU2	SÄKRING KOMPRESSOR 2	COMPRESSOR 2 FUSES	NH00gG 80A	WEBER
FU50	SÄKRING TRANSFORMATOR TC	AUX.TRANSF.CIRCUIT FUSES	CH10gG 12A	WEBER
FU51	SÄKRING MANÖVERKRETS 230V	AUX. CIRCUIT FUSE	CH10gG 4A	WEBER
FU52	SÄKRING MANÖVERKRETS 24V	CONTROL FUSE	CH10gG 4A	WEBER
FU56	SÄKRING FASFÖLJDSRELÄ	PHASE SEQ.RELAY FUSES	CH10gG 2A	WEBER
IE	EXTERN MANÖVER	EXTERNE INTERLOCK		
IV	FÖRREG.1 KONDENSORFLÄKT.	FANS INTERLOCK		
KA1	SPÄNNINGSRELÄ	VOLTAGE RELAY	RMIA210230AC	GAVAZZI
KA2	RELÄ FLÄKTLARM	FAN ALARM RELAY	RMIA45230AC	GAVAZZI
KA5	RELÄ FASFÖLJD	PHASE SEQUENCE RELAY	DPA01CM44	GAVAZZI
KM1	KONTAKTOR KOMPRESSOR 1	COMPRESSOR 1 CONTACTOR	LS 77 220V	AEG
KM2	KONTAKTOR KOMPRESSOR 2	COMPRESSOR 2 CONTACTOR	LS 77 220V	AEG
KM21	KONTAKT. 1 KONDENSORFLÄKT	FANS CONTACTOR	LS 4 220V	AEG
M1	KOMPRESSOR 1	COMPRESSOR 1	SZ 300	MANEUROP
M2	KOMPRESSOR 2	COMPRESSOR 2	SZ 300	MANEUROP
M21	FLÄKT	FAN	3 X 0,59 kW	
QS	HUVUDSTRÖMBRYTARE	MAIN SWITCH	SIRCO 4X200	SOCOMEK
R1	ELVÄRME KOMPR. 1	CRANKCASE HEATER COMP.1	130 W	MANEUROP
R2	ELVÄRME KOMPR. 1	CRANKCASE HEATER COMP.2	130 W	MANEUROP
RK3	ELVÄRME KONTOLLER	CONTROL ELECTRIC HEATER	120 OHM	
SP.H1	HÖGTRYCKSVAKT 1	HIGH PRESSURE SWITCH 1		
SP.H5	HÖGTRYCKSVAKT 2	HIGH PRESSURE SWITCH 2		
SP.L1	LÅGTRYCKSVAKT 1	LOW PRESSURE SWITCH 1		
SP.L2	LÅGTRYCKSVAKT 2	LOW PRESSURE SWITCH 2		
TC1	TRANSFORMATOR MANÖVER	AUX.TRANSFORMER	600 VA	
TC2	TRANSFORMATOR TERMINAL	TERMINAL TRANSFORMER	TRADR4W024	CAREL
YV.A1	MAGNETVENTIL 1 HÖG TEMP	HIGH TEMP.SOL.VALVE 1	L 30 220V	RANCO
YV.F1	MAGNETVENTIL 1 LÅG TEMP	LOW TEMP.SOL.VALVE 1	HM2 220V	CASTEL
YV.L1	MAGNETVENTIL 1	SOLENOID VALVE 1	HM2 220V	CASTEL
YV.M1	MAGNETVENTIL FÖRÅNGARE 1	EVAP.CONTROL VALVE 1	HM2 220V	CASTEL
YV.S1	MAGNETVENTIL INSPRUTNING 1	INJECTION SOL.VALVE 1	HM2 220V	CASTEL

TILLÄGG AV KOMPONENTER FÖR LE/HP ENHETER - COMPONENTS TO BE ADDED FOR LE/HP UNITS

A10	FRÅN/TILL FLÄKT STYRNING	ON/OFF FAN DRIVER	CONVONOFF0	CAREL
A13	TERMOSTAT BATTERI	BATTERY THERMOSTAT	RTA200B230	CAREL
BT13	GIVARE BATTERI	BATTERY PROBE	NTC	CAREL
E/1	EXTERN MANÖVER SOMMAR/VINTER	SUMMER/WINTER		
KA3	RELÄ VÄRMEPUMP (HP)	HP RELAY	RMIA45230AC	GAVAZZI
KAIE	RELÄ FRÅN/TILL	ON-OFF RELAY	RMIA45230AC	GAVAZZI
KM22	KONTAKTOR FLÄKTAR	FANS CONTACTOR	LS 4 220V	AEG
KM23	KONTAKTOR FLÄKTAR	FANS CONTACTOR	LS 4 220V	AEG
SP.C1	DEFR. TRYCKVAKT 1	DEFR. PRESS.SWITCH 1	016-H6750.B01	RANCO
YV.I1	4-VÄGS VENTIL 1	4 WAY SOLENOID VALVE 1	L 30 220V	RANCO
YV.L5	MAGNETVENTIL 5	SOLENOID VALVE 5	HM2 220V	CASTEL

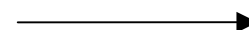

TILLÄGG AV KOMPONENTER FÖR VÄTSKEKYLAGGREGAT CH ENHETER - COMPONENTS TO BE ADDED FOR CH UNITS

Ref.	Beskrivning	Description	Typ/Type	Tillv./Manuf.
BT1	GIVARE INKOMMANDE	INLET USER PROBE	NTC	CAREL
BT2	GIVARE UTGÅENDE	OUTLET USER PROBE	NTC	CAREL
BT3	GIVARE, RETURLUFT	EXTERNAL AIR PROBE	NTC	CAREL
FU40	SÄKRINGAR ELVÄRMEKRETS	HEATER CIRCUIT FUSES	CH10gG 10A	WEBER
KM13	KONTAKTOR PUMP 1	PUMP 1 CONTACTOR	LS 4 220V	AEG
KM14	KONTAKTOR PUMP 2	PUMP 2 CONTACTOR	LS 4 220V	AEG
KM40	KONTAKTOR ELVÄRME FÖRÅNGARE	EVAP.ELECT.HEAT.CONTACTOR	LS 4 220V	AEG
M13	PUMP 1	PUMP 1	2,2 kW	
M14	PUMP 2	PUMP 2	2,2 kW	
QM13	MOTORSKYDD PUMP 1	PUMP MOTOR PROTECTION 1	MBS 25 4/6,3	AEG
QM14	MOTORSKYDD PUMP 2	PUMP MOTOR PROTECTION 2	MBS 25 4/6,3	AEG
R10	ELVÄRME TANK	TANK ELECT.HEATER	300 W	IRCA
R5	ELVÄRME FÖRÅNGARE 1	EVAP.ELECT.HEATER 1	170 W	RICA
R9	ELVÄRME VATTENKRETS	HYDRAULIC CIRC.HEATER	240W	FER
SP.W	FLÖDESVAKT	FLOW SWITCH		

TILLKOMMANDE KOMPONENTER FÖR VÄRMEPUMPS-UTFÖRANDE (HP)- COMPONENTS TO BE ADDED FOR HP UNITS

A10	PÅ/AV FLÄKT STYRNING	ON/OFF FAN DRIVER	CONVONOFF0	CAREL
A13	TERMOSTAT BATTERI	BATTERY THERMOSTAT	RTA200B230	CAREL
BPH1	TRYCK SIGNALOMV.1	PRESSURE TRANSDUCER 1	SPKT0033R0	CAREL
BT1	GIVARE INKOMMANDE	INLET USER PROBE	NTC	CAREL
BT13	GIVARE BATTERI	BATTERY PROBE	NTC	CAREL
BT2	GIVARE UTGÅENDE	OUTLET USER PROBE	NTC	CAREL
BT3	GIVARE, RETURLUFT	EXTERNAL AIR PROBE	NTC	CAREL
E/1	EXTERN MANÖVER SOMMAR/VINTER	SUMMER/WINTER		
FU40	SÄKRING ELVÄRMEKRETS	HEATER CIRCUIT FUSES	CH10gG 10A	WEBER
KA3	RELÄ VÄRMEPUMP (HP)	HP RELAY	RMIA45230AC	GAVAZZI
KM13	KONTAKTOR PUMP 1	PUMP 1 CONTACTOR	LS 4 220V	AEG
KM14	KONTAKTOR PUMP 2	PUMP 2 CONTACTOR	LS 4 220V	AEG
KM22	KONTAKTOR FLÄKTAR	FANS CONTACTOR	LS 4 220V	AEG
KM23	KONTAKTOR FLÄKTAR	FANS CONTACTOR	LS 4 220V	AEG
KM40	KONTAKTOR ELVÄRME FÖRÅNGARE	EVAP.ELECT.HEAT.CONTACTOR	LS 4 220V	AEG
M13	PUMP 1	PUMP 1	2,2 kW	
M14	PUMP 2	PUMP 2	2,2 kW	
QM13	MOTORSKYDD PUMP 1	PUMP MOTOR PROTECTION 1	MBS 25 4/6,3	AEG
QM14	MOTORSKYDD PUMP 2	PUMP MOTOR PROTECTION 2	MBS 25 4/6,3	AEG
R10	ELVÄRME TANK	TANK ELECT.HEATER	300 W	IRCA
R5	ELVÄRME FÖRÅNGARE 1	EVAP.ELECT.HEATER 1	170 W	RICA
R9	ELVÄRME VATTENKRETS	HYDRAULIC CIRC.HEATER	240 W	FER
SP.C1	DEFR. TRYCKVAKT 1	DEFR. PRESS.SWITCH 1	016-H6750.B01	RANCO
SP.W	FLÖDESVAKT	FLOW SWITCH		
YV.I1	4-VÄGS VENTIL 1	4 WAY SOLENOID VALVE 1	L 30 220V	RANCO
YV.L1	MAGNETVENTIL 1	SOLENOID VALVE 1	HM2 220V	CASTEL

TILLKOMMANDE KOMPONENTER FÖR AGGREGAT MED REDUCERAD PUMP - REDUCED PUMPS

KM13	KONTAKTOR REDUCERAD PUMP 1	REDUCED PUMP 1 CONTACTOR	LS 4 220V	AEG
KM14	KONTAKTOR REDUCERAD PUMP 2	REDUCED PUMP 2 CONTACTOR	LS 4 220V	AEG
M13	REDUCERAD PUMP 1	REDUCED PUMPS 1	1,5 kW	
M14	REDUCERAD PUMP 2	REDUCED PUMPS 2	1,5 kW	
QM13	MOTORSKYDD REDUCERAD PUMP 1	REDUC. PUMP MOTOR PROTEC.1	MBS 25 2,5/4	AEG
QM14	MOTORSKYDD REDUCERAD PUMP 2	REDUC. PUMP MOTOR PROTEC.2	MBS 25 2,5/4	AEG

TILLKOMMANDE KOMPONENTER FÖR AGGREGAT MED ÖVERDIMENSIONERAD PUMP - OVERSIZED PUMPS

KM13	KONTAKTOR ÖVERDIM. PUMP 1	OVERSIZED PUMP 1 CONTACTOR	LS 7 220V	AEG
KM14	KONTAKTOR ÖVERDIM. PUMP 2	OVERSIZED PUMP 2 CONTACTOR	LS 7 220V	AEG
M13	ÖVERDIMENSIONERAD PUMP 1	OVERSIZED PUMPS 1	4,0 kW	
M14	ÖVERDIMENSIONERAD PUMP 2	OVERSIZED PUMPS 2	4,0 kW	
QM13	MOTORSKYDD ÖVERDIM. PUMP 1	OVERSIZED PUMP MOTOR PROTEC.1	MBS 25 6,3/10	AEG
QM14	MOTORSKYDD ÖVERDIM. PUMP 2	OVERSIZED PUMP MOTOR PROTEC.2	MBS 25 6,3/10	AEG